

IT8800 High Power DC Electronic Load

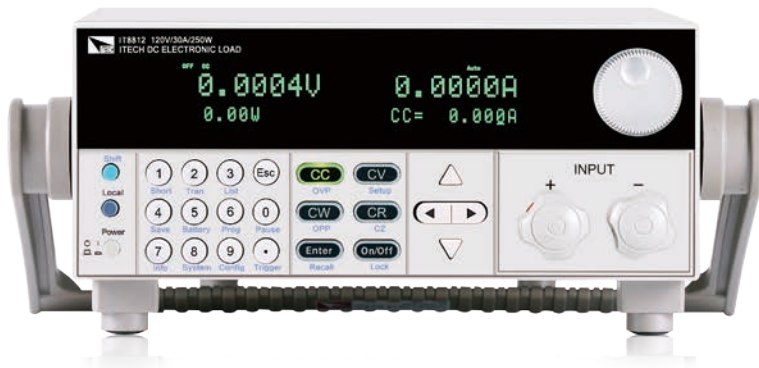

IT8800 series has wide power range 150W~10kW, voltage and current measurement speed up to 50KHZ, resolution up to 0.1mV/0.01mA, adjustable measurement current rising speed 0.0001A/us~2.5A/us, built-in RS232/GPIB/USB interface. IT8800 series has wide application fields because of its high performance products, it has been applied to LED lighting, aerospace, automotive electronics and other fields.

Applications

High power testing, battery test, power supply test, aerospace testing

Feature

- 150W-10kW/120-800V/15-500A
- CV/CC/CR/CW mode
- Remote sense
- Measurement resolution:0.1mV,0.01mA
- Dynamic mode: up to 25 KHz
- Adjustable current rising slope: 0.0001A/us~2.5A/us
- Measurement speed: up to 50KHz
- Dynamic test, short-circuit test function
- Rotary knob, making the operation more easier
- CR-LED test
- OCP / OVP / CPP / OTP/ Reverse polarity protection
- 100 groups memory capacity
- Power off memory function
- External analog control
- Support VISA/USBTMC/SCPI communication protocol
- Built-in RS232/USB/GPIB communication interface
- Software monitoring via PC

Model	Voltage	Current	Power	Size
IT8811	150W	120V	30A	1/2 2U
IT8812	250W	120V	30A	1/2 2U
IT8812B	200W	500V	15A	1/2 2U
IT8812C	250W	120V	60A	1/2 2U
IT8813	750W	120V	60A	3U
IT8813B	750W	500V	30A	3U
IT8813C	750W	120V	120A	3U
IT8814	1500W	120V	120A	3U
IT8814B	1200W	500V	60A	3U
IT8816	3KW	120V	240A	3U
IT8816B	2500W	500V	100A	3U
IT8817	4500W	120V	360A	6U
IT8817B	3600W	500V	120A	6U
IT8818	6KW	120V	480A	6U
IT8818B	5KW	500V	150A	6U
IT8819H	7.5KW	800V	80A	12U
IT8830	10KW	120V	500A	12U
IT8830B	10KW	500V	200A	12U
IT8830H	10KW	800V	100A	12U

Dynamic mode up to 25KHz

Dynamic mode operation allows the electronic load to be switched between the two setting parameters according to the setting rules. Dynamic mode can be used to test the dynamic nature of the power supply, e.g. when the computer disk drive run or stop, the dynamic load mode can simulate the change of operating current.

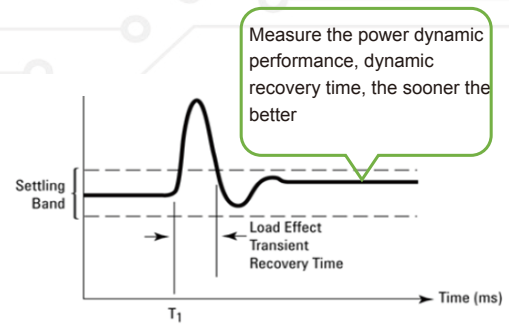

Voltage Rising/Falling time test

IT8800 provides unique measurement function to test voltage rising/falling time. Enter the measure menu under config, and set two voltage points. Then turn on display on timer function, and the rising / falling time is displayed on the screen after completing test.

This test is important for switching power supply testing and fuse testing.

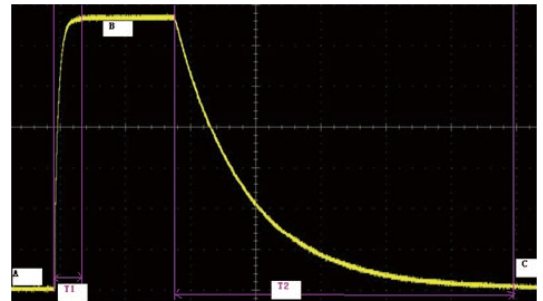

Adjustable Rising/Falling speed of current

List mode allows you to generate a complex current sequence. Moreover, the mode change can be synchronized with an internal or external signal, to accomplish dynamic and precise test. A list file includes following parameters: file name, step counts (range 2-84), time width of single step (0.00002s-3600s), step value and slope. The LIST function can make many kinds of complex sequences, to meet complicated test requirements.

IT8800 electronic load supports panel programming and computer software operation, especially for electronic product development, production line product aging, quality inspection and other complex application environment.

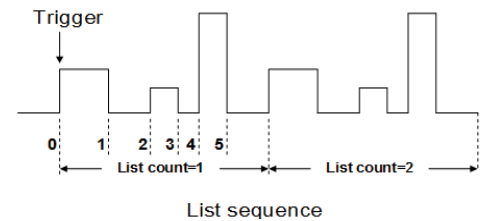

External analog test

IT8800 electronic load can control the loading voltage or current through the EXT PRG (positive and negative) analog port on the rear panel, connect 0-10V adjustable voltage to simulate 0- full-scale input in the EXT PRG terminal, so as to adjust the load input voltage and current value.

Analog control interface meets the control needs of industrial production, users can achieve output voltage control via PLC without the PC control.

Battery discharge testing in special aviation

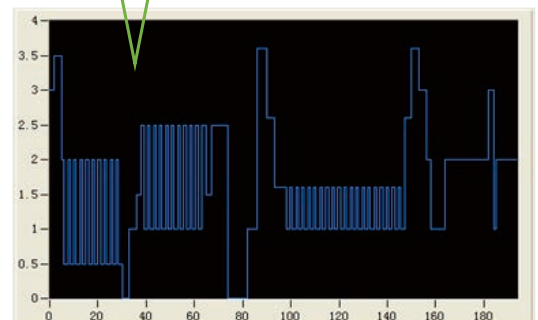

CR-LED test

AS we all know the LED constant power supply output waveform usually have large current ripple. This is because the traditional type DC loads can't simulate the actual characteristic of LED driver, its testing current and voltage will shake. Based on traditional CR mode, CR-LED mode of IT8800 series adds the setting item of diode break-over voltage. Only when the input voltage is above the set value, the DC load will start to work. Thus, the IT8800 series can simulate the actual characteristic of LED.

IT8800 unique LED mode can provide LED power drive test, which can be used in LED power simulation.

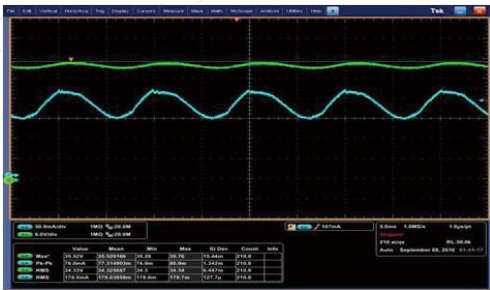

Current monitor

IT8800 series allows the users to monitor actual current through I-monitor terminal. Users could connect an oscilloscope to observe actual current. It will generate at 0-10V analog signal to represent to 0-100% rated current of the front panel.

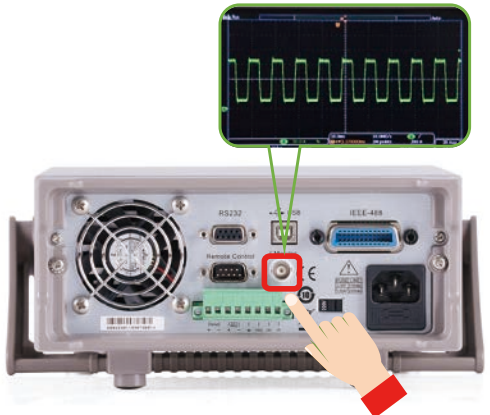

Battery discharge test function

IT8800 series electronic load can respectively set turn off voltage, cut-off capacity, discharge time through the panel and software to be as battery discharge cut-off conditions. The test is automatically stopped when the battery drops to the off voltage or has been discharged to the cut-off capacity or reaches the cut-off time. During the test, you can observe the battery voltage, discharge time and battery discharge capacity.

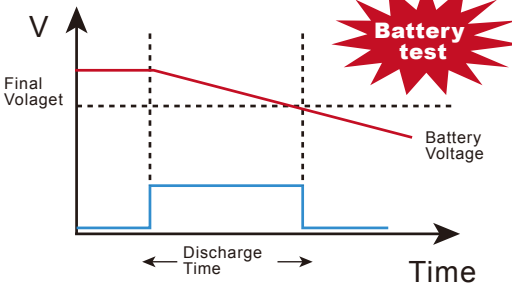

Working mode

The working mode of IT8800 series has CC, CV, CP, CR, and it will make you easy to simulate various characteristics of load, which can save cost greatly. It support OVP, OCP, OPP, OTP, reverse polarity protection and it can set the protection point of current, voltage, and power. In every condition, it will make auditory alarm and cut off the circuit to ensure the safety during test.

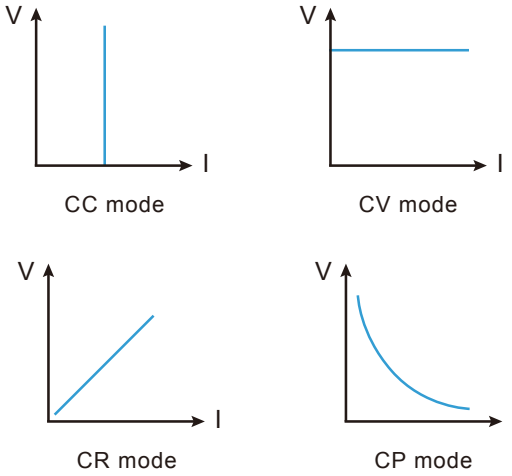

Auto test function

IT8800 auto test function can simulate many kinds of testing. It totally can edit 10 test files, and can make connection between one file and another. Also you can choose the condition to stop the test: stop when testing pass or fail. Its adjustable current speed rate of rising and falling can make auto test to simulate kinds of test waveform.

Supporting two loading modes

IT8800 series supports loading voltage setting, and it provides two kinds of load modes. Choosing Living means working goes after status, when choosing latch, it means work load point latch with loading states. It can meet different test requirements.

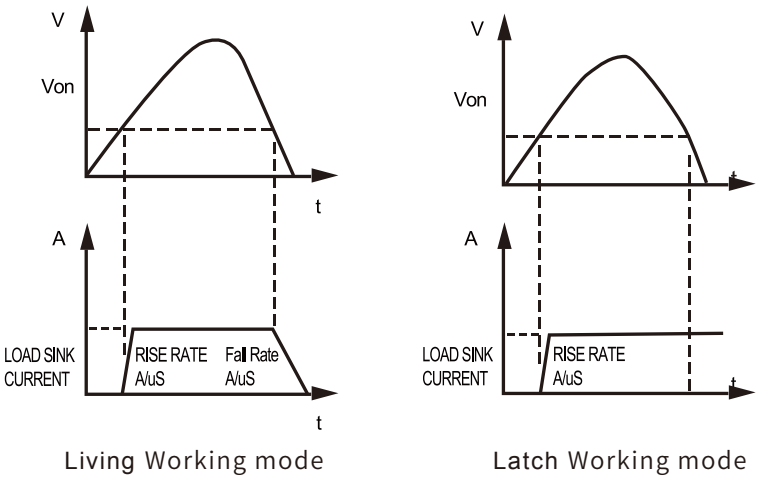

Remote sense function

In CC, CV, CR and CP mode, when load consume high current, it will cause large voltage-drop on the connection wires between tested instrument and terminals of load. Using remote sensing, you can sense the voltage at the power supply's terminals, effectively removing the effect of the voltage drop in the connection wires. In order to avoid the voltage-drop because of too long wires, remote test allows testing on the input terminals to improve the test accuracy.

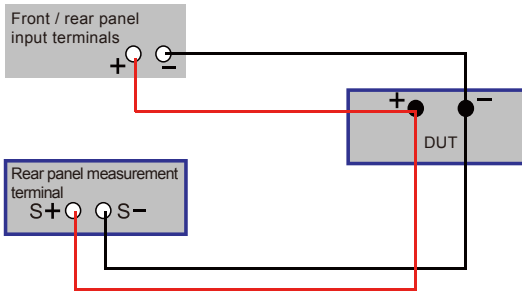

OCP/OPP test

OCP / OPP are mainly used in lithium battery protection board test, power module over current and over power point test. Through the built-in OCP and OPP function, users can test by built-in OCP program start current setting , cut-off current, step current, as well as the duration of each stage current, etc. IT8800 series can automatically capture the OCP point, with the automatic fast function, users can save a lot of verification time when using for design verification and production line system.

Panel operation

It is very convenient to operate the load panel, its shot-cut buttons are as follows: short circuit test, dynamic test, list test, data save, data recall, battery test, auto-test, test stop, test trigger, over current test, over power test.

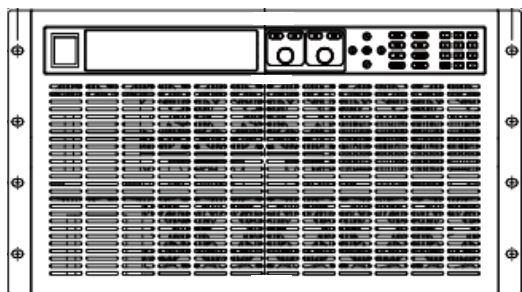
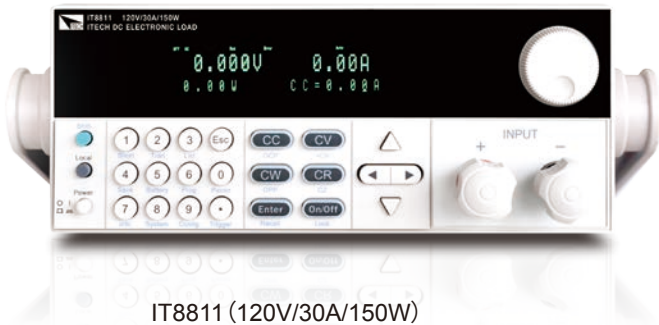



Field	DUT	Test items
Automotive electronics	Radio, Car heating seats; Car doors and windows switch	Judge the working current
	Auto-car doors and windows switch	Stability and aging test
	Car central control box	Stability and aging test
Battery	Power Battery	Discharge test
	Cell phone battery	Discharge test
	Solar battery	Discharge, efficiency and other tests
	Mobile power	Discharge test
power supply	Power supply module, power supply	Performance testing
	Regulated power supply, constant current source, constant voltage source	Performance testing
	Switching power supply	Performance testing
	Charger	Performance testing
	Power supply for medical equipment	Energy storage test
	Power supply for military, aerospace equipment, scientific research equipment	Performance testing
	UPS	Energy storage test
LED	LED drive power supply	Electrical parameters and stability test
Power electronic components	MOSFET, IGBT	Performance testing
	Capacitors, rectifiers	Performance testing
	PFC module	Performance testing
Fuse	Fuse	Fuse time test



IT8800 High Power DC Electronic Load

Electronic Load

IT8811/12 Specifications

		IT8811		IT8812		IT8812B		IT8812C	
Rated (0~40°C)	Input voltage	0~120V		0~120V		0~500V		0~120V	
	Input current	0~3A	0~30A	0~3A	0~30A	0~3A	0~15A	0~6A	0~60A
	Input power	150W		250W		200W		250W	
	Min operating voltage	0.11V at 3A	1.1V at 30A	0.11V at 3A	1.1V at 30A	0.9V at 3A	4.5V at 15A	0.18V at 6A	1.8V at 60A
CV mode	Range	0.1~18V	0.1~120V	0.1~18V	0.1~120V	0.1~50V	0.1~500V	0.1~18V	0.1~120V
	Resolution	1mV	10mV	1mV	10mV	1mV	10mV	1mV	10mV
	Accuracy	±(0.05%+0.025%FS)		±(0.05%+0.025%FS)		±(0.05%+0.025%FS)		±(0.05%+0.025%FS)	
CC mode	Range	0~3A	0~30A	0~3A	0~30A	0~3A	0~15A	0~6A	0~60A
	Resolution	0.1mA	1mA	0.1mA	1mA	0.1mA	1mA	0.1mA	1mA
	Accuracy	± (0.05% + 0.05%FS)							
CR mode ^{*1}	Range	0.05Ω~10Ω	10Ω~7.5KΩ	0.05Ω~10Ω	10Ω~7.5KΩ	0.3Ω~10Ω	10Ω~7.5KΩ	0.05Ω~10Ω	10Ω~7.5KΩ
	Resolution	16 bit							
	Accuracy	0.01% + 0.08s	0.01% + 0.0008s	0.01% + 0.08s	0.01% + 0.0008s	0.01% + 0.08s	0.01% + 0.0008s	0.01% + 0.08s	0.01% + 0.0008s
CP mode ^{*2}	Range	150W		250W		200W		250W	
	Resolution	10mW		10mW		10mW		10mW	
	Accuracy	0.1% + 0.1%FS		0.1% + 0.1%FS		0.1% + 0.1%FS		0.2% + 0.2%FS	
Dynamic mode ^{*3}	Dynamic mode								
	CC mode								
	T1&T2	20 μs~3600s / Res:1 μs							
	Accuracy	5 μs±100 ppm							
Rise / fall slope	0.0001~0.25A/μs	0.001~2.5A/μs	0.0001~0.25 A/μs	0.001~2.5 A/μs	0.0001~0.1 A/μs	0.001~1 A/μs	0.0001~0.25 A/μs	0.001~2.5 A/μs	
Measuring range									
Readback Voltage	Range	0~18V	0~120V	0~18V	0~120V	0~50V	0~500V	0~18V	0~120V
	Resolution	0.1mV	1mV	0.1mV	1mV	1mV	10mV	0.1mV	1mV
	Accuracy	± (0.025% + 0.025%FS)							
Readback Current	Range	0~3A	0~30A	0~3A	0~30A	0~3A	0~15A	0~6A	0~60A
	Resolution	0.01mA	0.1mA	0.01mA	0.1mA	0.01mA	0.1mA	0.1mA	1mA
	Accuracy	± (0.05% + 0.05%FS)		± (0.05% + 0.05%FS)		± (0.05% + 0.05%FS)		± (0.05% + 0.1%FS)	
Readback Power	Range	150W		250W		200W		250W	
	Resolution	10mW		10mW		10mW		10mW	
	Accuracy	± (0.1% + 0.1%FS)		± (0.1% + 0.1%FS)		± (0.1% + 0.1%FS)		± (0.2% + 0.2%FS)	
Protected range									
Over power protection	≅ 160W		≅ 260W		≅ 210W		≅ 260W		
Over current protection	≅ 3.3A	≅ 33A	≅ 3.3A	≅ 33A	≅ 3.3A	≅ 16.5A	≅ 6.6A	≅ 66A	
Over voltage protection	≅ 130V		≅ 130V		≅ 530V		≅ 130V		
Over temperature protection	≅ 85°C								
Specifications									
Short circuit	Current	≅ 3.3/3A	≅ 33/30A	≅ 3.3/3A	≅ 33/30A	≅ 3.3/3A	≅ 16.5/15A	≅ 6.6 /6A	≅ 66 A/60A
	Voltage	0V							
	Resistance	≅ 35mΩ		≅ 35mΩ		≅ 300mΩ		≅ 30 mΩ	
Input terminal impedance	300KΩ		300KΩ		1MΩ		300 KΩ		
Size(W*H*D)	214.5 mm* 88.2 mm* 354.6mm								

*1 Voltage/current input value is not less than 10% FS (FS for full scale)

*2 Voltage/current input values is not less than 10% FS

*3 Up/down slope: 10% ~ 90% current rising slope when from 0 to the maximum current

* This information is subject to change without notice

IT8811/12 Dimension figure

1/2 2U, 150 W~300 W

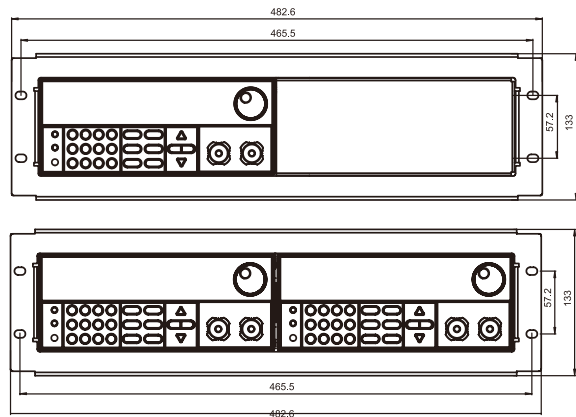
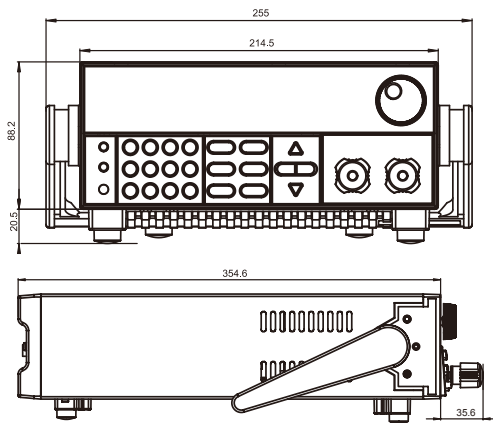

Unit: mm

IT8813/14 Specifications

	IT8813	IT8813B	IT8813C	IT8814	IT8814B						
Rated (0~40°C)	Input voltage	0~120V		0~500V							
	Input current	0~6A	0~60A	0~3A	0~30A	0~12A	0~120A	0~12A	0~120A	0~6A	0~60A
	Input power	750W		750W		750W		1500W		1200W	
	Min operating voltage	0.1Vat6A	1.0Vat60A	0.36Vat3A	3.6V at 30A	0.12V/12A	1.2V/120A	0.12Vat12A	1.2Vat120A	0.36V / 6A	3.6V / 60A
CV mode	Range	0.1~18V	0.1~120V	0.1~50V	0.1~500V	0.1~18V	0.1~120V	0.1~18V	0.1~120V	0.1~50V	0.1~500V
	Resolution	1mV	10mV	1mV	10mV	1mV	10mV	1mV	10mV	1mV	10mV
	Accuracy	±(0.025%+0.05% FS)		±(0.025%+0.05%FS)		±(0.025%+0.05%FS)		±(0.025%+0.05%FS)		±(0.025%+0.05%FS)	
CC mode	Range	0~6A	0~60A	0~3A	0~30A	0~12A	0~120A	0~12A	0~120A	0~6A	0~60A
	Resolution	0.1mA	1mA	0.1mA	1mA	1mA	10mA	1mA	10mA	0.1mA	1mA
	Accuracy	± (0.05% + 0.05%FS)		±(0.05%+0.1%FS)		±(0.05%+0.1%FS)		±(0.05%+0.05%FS)		±(0.05%+0.05%FS)	
CR mode ^{*1}	Range	0.02Ω~10Ω	10Ω~7.5kΩ	0.15Ω~10Ω	10Ω~7.5KΩ	0.02Ω~10Ω	10Ω~7.5KΩ	0.01Ω~10Ω	10Ω~7.5kΩ	0.1Ω~10Ω	10Ω~7.5kΩ
	Resolution	16 bit									
	Accuracy	0.01%+0.08s	0.01%+0.0008s	0.01%+0.08s	0.01%+0.0008s	0.01%+0.08s	0.01%+0.0008s	0.01%+0.08s	0.01%+0.0008s	0.01%+0.08s	0.01%+0.0008s
CP mode ^{*2}	Range	750W		750W		750W		1500W		1200W	
	Resolution	10mW		10mW		10mW		100mW		100mW	
	Accuracy	0.2% + 0.2% FS		0.2% + 0.2% FS		0.2% + 0.2% FS		0.2% + 0.2% FS		0.2% + 0.2% FS	
Dynamic mode ^{*3}	Dynamic mode										
	CC mode										
	T1&T2	20μs~3600s / Res:1 μs									
	Accuracy	5μs±100 ppm									
Rise / fall slope	0.0001-0.25A/μs	0.001-2.5A/μs	0.0001-0.1A/μs	0.001-1A/μs	0.001-0.25A/μs	0.01-2.5A/μs	0.001-0.25A/μs	0.01-2.5A/μs	0.0001-0.1A/μs	0.001-1A/μs	
Readback Voltage	Measuring range										
	Range	0~18V	0~120V	0~50V	0~500V	0~18V	0~120V	0~18V	0~120V	0~50V	0~500V
	Resolution	1mV	10mV	1mV	10mV	1mV	10mV	1mV	10mV	1mV	10mV
	Accuracy	± (0.025% + 0.025%FS)									
Readback Current	Range	0~6A	0~60A	0~3A	0~30A	0~12A	0~120A	0~12A	0~120A	0~6A	0~60A
	Resolution	0.1mA	1mA	0.1mA	1mA	1mA	10mA	1mA	10mA	0.1mA	1mA
	Accuracy	± (0.05% + 0.05%FS)		± (0.05% + 0.05%FS)		±(0.05%+0.1%FS)		± (0.05% + 0.05%FS)		± (0.05% + 0.05%FS)	
Readback Power	Range	750W		750W		750W		1500W		1200W	
	Resolution	10mW		10mW		10mW		100mW		100mW	
	Accuracy	± (0.2% + 0.2%FS)		± (0.2% + 0.2%FS)		± (0.2% + 0.2%FS)		± (0.2% + 0.2%FS)		± (0.2% + 0.2%FS)	
Protected range											
Over power protection	≅760W		≅760W		≅760W		≅1550W		≅1250W		
Over current protection	≅6.6A	≅66A	≅3.3A	≅33A	≅13.2A	≅132A	≅13.2/12A	≅132/120A	≅6.6A	≅66A	
Over voltage protection	≅130V		≅530V		≅130V		≅130V		≅530V		
Over temperature protection	≅85°C										
Specifications											
Short circuit	Current	≅6.6/6A	≅66/60A	≅3.3/3A	≅13.2/12A 132/120A		≅13.2/12A	≅132/120A	≅6.6/16A	≅66/160A	
	Voltage	0V									
	Resistance	≅15mΩ		≅120mΩ		≅10mΩ		≅10mΩ		≅60mΩ	
Input terminal impedance	300KΩ		1MΩ		300KΩ		300KΩ		1MΩ		
Size(W*H*D)	439 mm* 133.3 mm* 580 mm										

*1 Voltage/current input value is not less than 10% FS (FS for full scale)

*2 Voltage/current input values is not less than 10% FS

*3 Up/down slope: 10% ~ 90% current rising slope when from 0 to the maximum current

* This information is subject to change without notice

IT8813/14/16 Dimension figure (3U, 750 W~3000W)

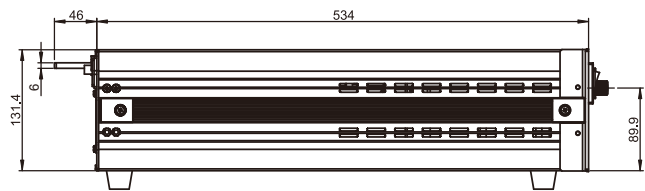
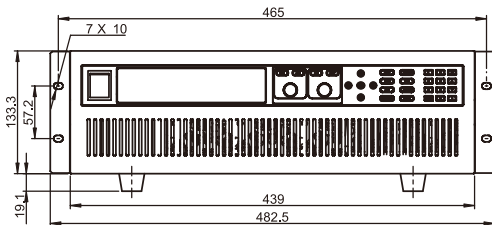

Unit: mm

IT8816/17 Specifications

	IT8816		IT8816B		IT8817		IT8817B			
Rated (0~40°C)	Input voltage	0~120 V		0~500 V		0~120 V		0~500 V		
	Input current	0~24 A	0~240 A	0~10 A	0~100 A	0~36 A	0~360 A	0~12 A	0~120 A	
	Input power	3000 W		2.5 KW		4500 W		3.6 KW		
	Min operating voltage	0.12Vat24A	1.2Vat 240A	0.3 V at 10 A		3 V at 100 A		0.3 V at 12A		
CV mode	Range	0.1~18 V	0.1~120 V	0.1~50 V	0.1~500 V	0.1~18 V	0.1~120 V	0.1~50 V	0.1~500 V	
	Resolution	1 mV	10 mV	1 mV	10 mV	1 mV	10 mV	1 mV	10 mV	
	Accuracy	±(0.025%+0.05% FS)		±(0.025%+0.05%FS)		±(0.025%+0.05%FS)		±(0.025%+0.05%FS)		
CC mode	Range	0~24 A	0~240 A	0~10 A	0~100 A	0~36 A	0~360 A	0~12 A	0~120 A	
	Resolution	1 mA	10 mA	1 mA	10 mA	1 mA	10 mA	1 mA	10 mA	
	Accuracy	± (0.05% + 0.05%FS)		± (0.05% + 0.05%FS)		± (0.05% + 0.1%FS)		± (0.05%+0.05%FS)		
CR mode ^{*1}	Range	0.01 Ω~10 Ω	10 Ω~7.5 KΩ	0.03 Ω~10 Ω	10 Ω~7.5 KΩ	0.01Ω~10Ω	10Ω~7.5KΩ	0.03Ω~10Ω	10Ω~7.5kΩ	
	Resolution	16 bit								
	Accuracy	0.01% + 0.08S	0.01%+0.0008S	0.01% + 0.08S	0.01% + 0.0008S	0.01% + 0.08S	0.01% + 0.0008S	0.01%+0.08S	0.01%+0.0008S	
CP mode ^{*2}	Range	3000 W		2.5 kW		4500W		3.6kW		
	Resolution	100 mW								
	Accuracy	0.2% + 0.2% FS								
Dynamic mode										
Dynamic mode ^{*3}	CC mode									
	T1&T2	20 μS~3600 S / Res:1 μS								
	Accuracy	5 μS±100 ppm								
	Rise / fall slope	0.001~0.25A/μS	0.01~2.5 A/μS	0.001~0.1 A/μS	0.01~1 A/μS	0.001~0.25A/μS	0.01~2.5 A/μS	0.001~0.1 A/μS	0.01~1 A/μS	
Measuring range										
Readback Voltage	Range	0~18 V	0~120 V	0~50 V	0~500 V	0~18 V	0~120 V	0~50 V	0~500 V	
	Resolution	1 mV	10 mV	1 mV	10 mV	1 mV	10 mV	1 mV	10 mV	
	Accuracy	± (0.025% + 0.025%FS)								
Readback Current	Range	0~24 A	0~240 A	0~10 A	0~100 A	0~36 A	0~360 A	0~12 A	0~120 A	
	Resolution	1 mA	10 mA	1 mA	10 mA	1 mA	10 mA	1 mA	10 mA	
	Accuracy	± (0.05% + 0.05%FS)								
Readback Power	Range	3000 W		2.5 KW		4500 W		3.6 kW		
	Resolution	100 mW								
	Accuracy	± (0.2% + 0.2%FS)								
Protected range										
Over power protection	≅ 3050 W		≅ 2550 W		≅ 4550 W		≅ 3650 W			
Over current protection	≅ 26.4 A	≅ 264 A	≅ 11 A	≅ 110 A	≅ 39.6 A	≅ 396 A	≅ 13.2 A	≅ 132 A		
Over voltage protection	≅ 130 V		≅ 530 V		≅ 130 V		≅ 530 V			
Over temperature protection	≅ 85°C									
Specifications										
Short circuit	Current	≅ 26.4/24 A	≅ 264/240A	≅ 11/10 A	≅ 110/100 A	≅ 39.6 /36A	≅ 396/360 A	≅ 13.2 /12A	≅ 132/120 A	
	Voltage	0 V								
	Resistance	≅ 5 mΩ		≅ 30 mΩ		≅ 4 mΩ		≅ 25 mΩ		
Input terminal impedance	300kΩ			1 MΩ			300 kΩ		1 MΩ	
Size(W*H*D)	439 mm* 133.3 mm* 580 mm				439 mm* 266 mm* 590 mm					

*1 Voltage/current input value is not less than 10% FS (FS for full scale)

*2 Voltage/current input values is not less than 10% FS

*3 Up/down slope: 10% ~ 90% current rising slope when from 0 to the maximum current

* This information is subject to change without notice

IT8817 Dimension figure (6U, 3.6 kW~4.5kW)

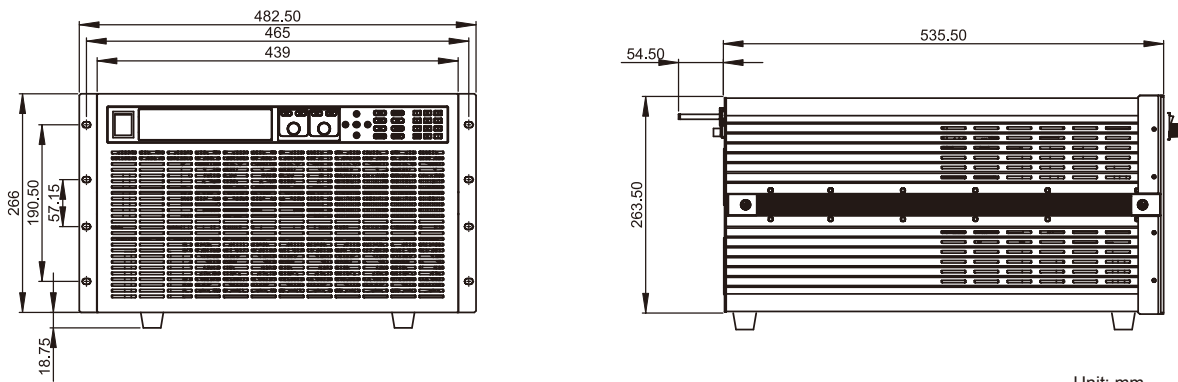

Unit: mm

IT8818 Specifications

		IT8818		IT8818B	
Rated (0~40 °C)	Input voltage	0~120 V		0~500 V	
	Input current	0~48 A	0~480 A	0~15 A	0~150 A
	Input power	6 kW		5 kW	
	Min operating voltage	0.15 V at 48 A	1.5 V at 480 A	0.3 V at 15 A	3 V at 150 A
CV mode	Range	0.1~18 V	0.1~120 V	0.1~50 V	0.1~500 V
	Resolution	1 mV	10 mV	1 mV	10 mV
	Accuracy	±(0.025%+0.05% FS)	±(0.025%+0.05%FS)	±(0.025%+0.05%FS)	±(0.025%+0.05%FS)
CC mode	Range	0~48 A	0~480 A	0~15 A	0~150 A
	Resolution	1 mA	10 mA	1 mA	10 mA
	Accuracy	± (0.05% + 0.1%FS)		± (0.05% + 0.05%FS)	
CR mode ^{*1}	Range	0.005 Ω~10 Ω	10 Ω~7.5 KΩ	0.03 Ω~10 Ω	10 Ω~7.5 KΩ
	Resolution		16 bit		
	Accuracy	0.01% + 0.08S	0.01% + 0.0008S	0.01% + 0.08S	0.01%+0.0008S
CP mode ^{*2}	Range	6 kW		5 kW	
	Resolution	100 mW		100 mW	
	Accuracy	0.2% + 0.2% FS		0.2% + 0.2% FS	
Dynamic mode					
Dynamic mode ^{*3}	T1&T2		20 μS~3600 S / Res:1 μS		
	Accuracy		5 μS±100 ppm		
	Rise / fall slope	0.001~0.25A/μS	0.01~2.5 A/μS	0.001~0.1 A/μS	0.01~1 A/μS
Measuring range					
Readback Voltage	Range	0~18 V	0~120 V	0~50 V	0~500 V
	Resolution	1 mV	10 mV	1 mV	10 mV
	Accuracy		± (0.025% + 0.025%FS)		
Readback Current	Range	0~48 A	0~480 A	0~15 A	0~150 A
	Resolution	1 mA	10 mA	1 mA	10 mA
	Accuracy	± (0.05% + 0.05%FS)		± (0.05% + 0.05%FS)	
Readback Power	Range	6 kW		5 kW	
	Resolution	100 mW		100 mW	
	Accuracy	± (0.2% + 0.2%FS)		± (0.2% + 0.2%FS)	
Protected range					
Over power protection		≅6050 W		≅5050 W	
Over current protection		≅52.8 A	≅528 A	≅16.5A	≅165 A
Over voltage protection		≅130 V		≅530 V	
Over temperature protection				≅85°C	
Specifications					
Short circuit	Current	≅52.8/48 A	≅528/480 A	≅16.5/15 A	≅165/150A
	Voltage		0 V		
	Resistance	≅3 mΩ	≅3 mΩ	≅20 mΩ	≅20 mΩ
Input terminal impedance		300 kΩ		1mΩ	
Size(W*H*D)		439 mm* 266 mm* 590 mm			

*1 Voltage/current input value is not less than 10% FS (FS for full scale)

*2 Voltage/current input values is not less than 10% FS

*3 Up/down slope: 10% ~ 90% current rising slope when from 0 to the maximum current

* This information is subject to change without notice

IT8818 Dimension figure (6U, 5kW~6kW)

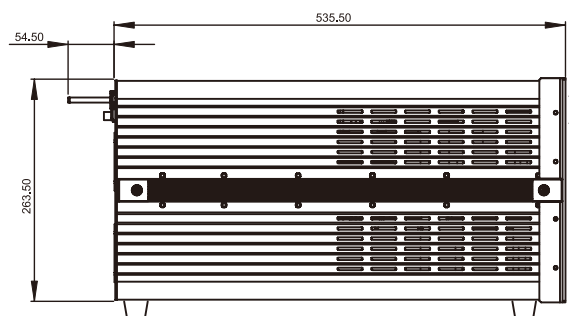
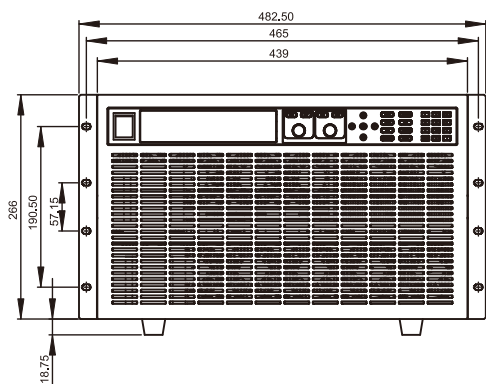

Unit: mm

IT8819/IT8830 Specifications

		IT8819H		IT8830		IT8830H	
Rated (0~40°C)	Input voltage	0~800V		0~120V		0~800V	
	Input current	0~8A	0~80A	0~50A	0~500A	0~10A	0~100A
	Input power	7500W		10KW		10KW	
	Min operating voltage	0.28V/8A	2.8V/80A	0.1V/50A	1V/500A	0.3V/10A	3V/100A
CV mode	Range	0.1~80V	0.1~800V	0.1~18V	0.1~120V	0.1~80V	0.1~800V
	Resolution	1 mV	10 mV	1 mV	10 mV	1 mV	10 mV
	Accuracy	±(0.05%+0.05%FS)		±(0.025%+0.05%FS)		±(0.05%+0.05%FS)	
CC mode	Range	0~8A	0~80A	0~50A	0~500A	0~10A	0~100A
	Resolution	1 mA	10 mA	1 mA	10 mA	1 mA	10 mA
	Accuracy	±(0.05%+0.05%FS)		±(0.05%+0.1%FS)		±(0.05%+0.05%FS)	
CR mode ^{*1}	Range	0.05Ω~10Ω	10Ω~7.5KΩ	0.005Ω~10Ω	10Ω~7.5KΩ	0.05Ω~10Ω	10Ω~7.5KΩ
	Resolution	16 bit		16 bit		16 bit	
	Accuracy	0.01%+0.08S	0.01%+0.0008S	0.01%+0.08S	0.01%+0.0008S	0.01%+0.08S	0.01%+0.0008S
CP mode ^{*2}	Range	7500W		10KW		10KW	
	Resolution	1W		1W		1W	
	Accuracy	0.2%+0.25%FS		0.2%+0.2%FS		0.2%+0.2%FS	
Measuring range							
Readback Voltage	Range	0~80V	0~800V	0~18V	0~120V	0~80V	0~800V
	Resolution	1 mV	10 mV	1 mV	10 mV	1 mV	10 mV
	Accuracy	±(0.025%+0.025%FS)		±(0.025%+0.025%FS)		±(0.025%+0.025%FS)	
Readback Current	Range	0~8A	0~80A	0~50A	0~500A	0~10A	0~100A
	Resolution	1 mA	10 mA	1 mA	10 mA	1 mA	10 mA
	Accuracy	±(0.05%+0.05%FS)		±(0.05%+0.05%FS)		±(0.05%+0.05%FS)	
Readback Power	Range	7500W		10kW		10kW	
	Resolution	1W		1W		1W	
	Accuracy	±(0.2%+0.25%FS)		±(0.2%+0.2%FS)		±(0.2%+0.2%FS)	
Protected range							
Over power protection	≅ 7550W		≅ 10.1KW		≅ 10.1KW		
Over current protection	≅ 8.8A	≅ 88A	≅ 55A	≅ 550A	≅ 11A	≅ 110A	
Over voltage protection	≅ 850V		≅ 130V		≅ 850V		
Over temperature protection	≅ 85°C		≅ 85°C		≅ 85°C		
Specifications							
Short circuit	Current	≅ 8.8/8A	≅ 88/80A	≅ 55/50A	≅ 550/500A	≅ 11/10A	≅ 110/100A
	Voltage	0V		0V		0V	
	Resistance	≅ 35mΩ		≅ 2mΩ		≅ 30mΩ	
Input terminal impedance	≅ 2MΩ		300KΩ		2MΩ		
Size(W*H*D)	12U		12U		12U		

*1 Voltage/current input value is not less than 10% FS (FS for full scale)

*2 Voltage/current input values is not less than 10% FS

* This information is subject to change without notice

IT8819H Dimension figure

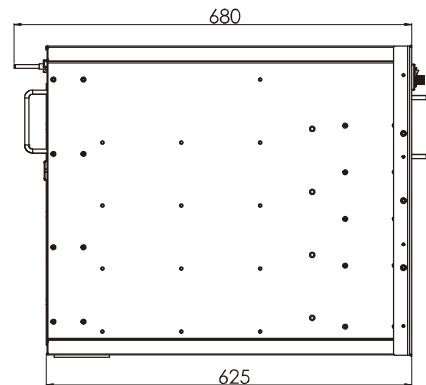
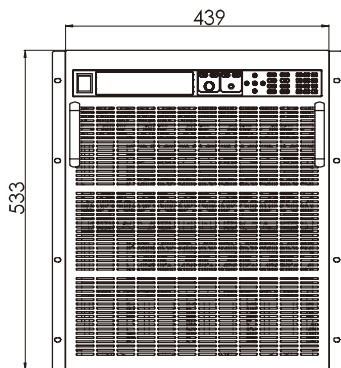

Unit: mm