

IT2800

Graphical Source Measure Unit



Your Power Testing Solution

IT2800

Graphical Source Measure Unit



The IT2800 Series are compact and cost-effective bench-top Source Measure Units (SMUs) with the capability to source and measure both voltage and current. These capabilities make the IT2800 Series ideal for a wide variety of IV (current versus voltage) measurement tasks that require both high resolution and accuracy.

The IT2800 Series combine the capabilities of a voltage source, a current source, a voltage meter, a current meter and an ohmmeter (along with the capability to switch easily between these various functions). This ensures the independent measurement of IV characteristic in 4-quadrant. Easily and accurately measure current and voltage using a single instrument without the need to manually change any connections. Besides, the IT2800 Series(SMU) also possess a voltage and current limit feature that allows the user to set limits and to protect devices from damage. Besides, it also provides a broad range of IV measurements for various double or triple terminal devices.

With a current range of 10fA to 10A and a voltage range of 100nV to 1000V, the IT2800 series SMU has capabilities that allow it to perform more than just simple DC and pulsed measurements to prevent errors in measurement results due to the device's own heating. In addition, the IT2800 series SMUs are equipped with high-speed, reliable fiber optic parallel mode, which enables them to work stably and reliably among multiple SMUs and exchange large amounts of data to fulfill a wide variety of test requirements. Excellent Front Panel GUI with 5 inch touch display supports various view modes, to help engineers significantly improve the efficiency of testing.

The IT2800 Series provide best-in-class performance for voltage, current sourcing, excellent precision and various test functions. These capabilities make it suitable for a variety of test applications: discrete semiconductor devices, passive devices, transient suppression devices, laser diodes, TVS, varistors, etc.

FEATURE

- 5 inch touch display supports both graphical and numerical view modes.
- Combining the capabilities of six devices in one: Voltage Source, Current Source, 6 ½ Digital Multimeter (DCV,DCI, ohms), Battery Simulator, electronic load and Pulse Generator
- Integrating 4-quadrant sourcing & measuring capabilities, and supporting Two-wire & Four-wire measurement
- Resolution up to 10fA/100nV, sampling rate up to 10us.
- Three graphic display modes: Graph View, Scope View and Record View.
- Built-in battery simulator function, suitable for IOT low power precision measurement
- Sweep Capability: Linear/Log/ Pulsed-line AR/Pulsed-Log and LIST
- Multi-channel and simultaneous operation design, with parallel testing capability
- Built-in resistance, power, and Math measurement features
- With GUARD output function, suitable for low current measurement
- Front USB port used for data storage, screen capture, or test configuration import
- Built-in Digital IO/USB/LAN communication interface

Model	Voltage	Current	Power	Channels
IT2801	1000V	1A	20W	Φ 1
IT2805	200V	1.5A	20W	Φ 1
IT2806	200V	3A DC/ 10A Pulse	20W	Φ 1

Your Power Testing Solution

IT2800 Graphical Source Measure Unit

Typical Applications

SMUs are ideal for I-V characteristics and high precision measurements for a wide range of applications, such as semiconductor testing, optoelectronic device testing, active/passive component testing, and material characterization. The IT2800 series SMU combines ATE integration with desktop usage requirements. It is an excellent product to meet the diverse testing needs from R&D to production testing and automated manufacturing, from industrial development to university research

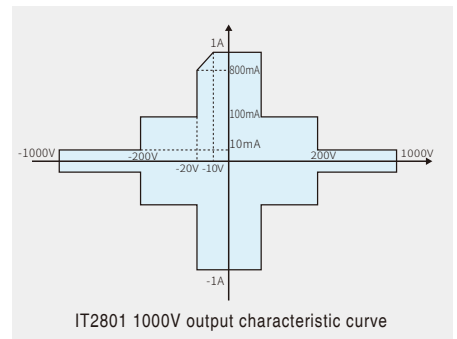
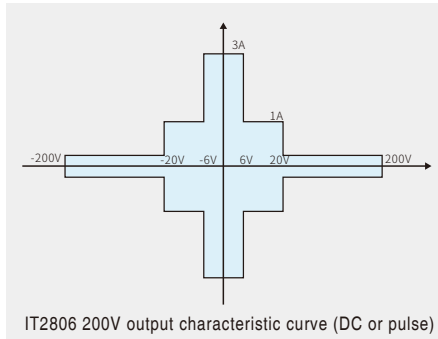
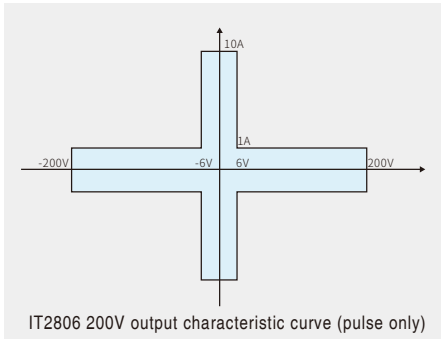

Batteries and optoelectronic device

- Laser light diode/LEDS/AMOLEDs/Mini LEDs
- Solar cells
- Low power cell
- Photodetectors, sensors

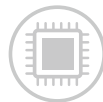

Semiconductors, discrete and passive components

- Wafer Die
- Power LCS (Analog chip, RF chip, Power management chip...)
- Discrete devices (BJTs, FETs, IGBT, SiC, GaN, Diodes...)
- Passive components (Varistors, thermistors, switches, resistors...)



Material characterization

- Graphene material
- Nano materials and other new materials
- CNT(carbon nano tube)
- Giant magnetic resistance (GMR)
- Organic devices (e-ink)



Your Power Testing Solution

IT2800 Graphical Source Measure Unit

Six in one high precision SMU, reduce your test cost

Performing IV measurements with conventional instruments such as voltage/current sources, pulse generator, high precision voltage/current meters, etc. is complicated and costly. It takes up limited test bench space and requires engineers control and synchronize programming of multiple devices to perform an accurate measurement.

The IT2800 series SMU provides engineers with an economical and efficient solution. It integrates different source and measurement capabilities into one compact form factor of 1/2 2U size, which can accurately source and measure voltage and current. It combine the capabilities of six devices including:

6 ½ digital multimeter (VIR measurement), battery simulator and pulse Generator

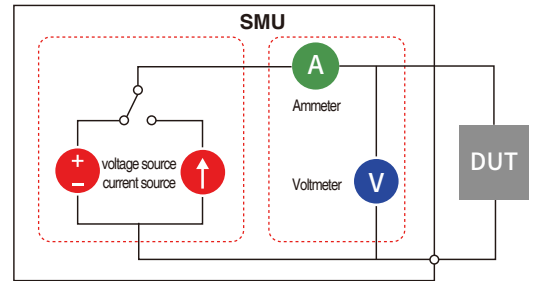
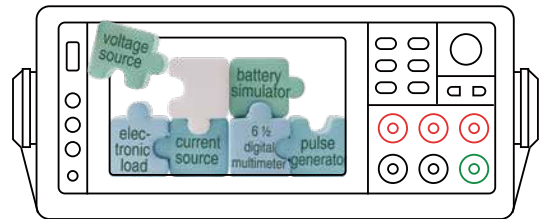

Intuitive graphical display, fast access to product features

The IT2800's front panel has many features that improve the speed of interactive use, user friendliness and ease of operation. These include a 5 inch color LCD display, a USB2.0 memory I/O port, a rotating navigation button, a trigger button, function keys and popular banana jack. The USB2.0 memory port supports easy data storing, test configuration file import and system upgrade.

The IT2800 Series supports both graphical and numerical test results view modes. The intuitive graph view, scope view and record view greatly improves the productivity of bench-top tests and IV characteristic analysis.

Graph view

Graph View displays measurement results on XY graphs (such as I-V and V-t curves) on up to 2 channels. This is useful for quick evaluation of device characteristics, especially those obtained from sweep measurements.

Scope view

Scope view draws I-t or V-t curves in real time during the test. It can capture and export up to 600,000 data points. This function is independent of other functions and can be run simultaneously. In Scope view mode, the sampling rate is up to 100,000 points per second (10us), which facilitates the tester to monitor low frequency transient signals.

Record view

Record view allows the user to view historical waveforms and table data over a period of time. The minimum sampling time interval is 100US, and up to 1 million points of data can be recorded. It also supports exporting to spreadsheets (.csv) for further analysis, greatly improving the efficiency of testing and debugging.



Standard and LIST sweep capabilities

IT2800 Series features standard and LIST sweep capabilities. Under standard sweep mode, it supports parameters such as linear and logarithmic modes, single and double sweep functions and constant and pulsed sweep operation. List sweep functions can efficiently perform arbitrary waveform output which is useful when characterizing devices where the test response varies greatly depending upon the applied voltage or current. The user can use Excel import or panel edit to generate sweep curves of any shape with up to 99,999 data points can be import, which is an ideal choice for testing U-I and I-U features.

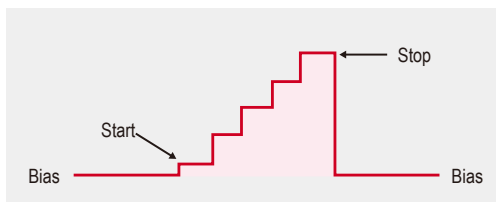

Linear staircase sweep

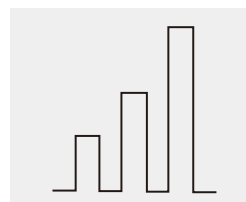

Pulsed linear sweep

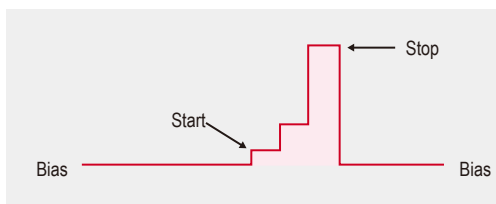

Logarithmic staircase sweep

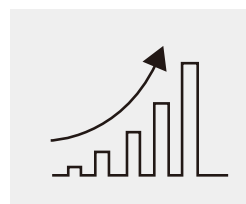

Pulsed logarithmic sweep

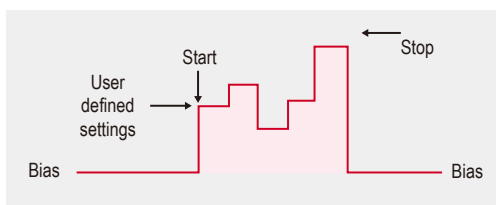

Custom sweep

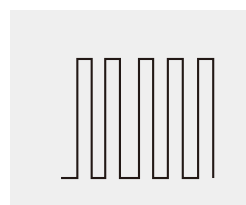

Constant pulsed sweep

Limit test, improve the efficiency of batch product sorting

Limit test is to make pass or fail judgment on measurement data or mathematical operation result data, which are obtained by the channel. A maximum of 12 limits (LIMIT1 to LIMIT12) can be defined. Each limit test status corresponds to 12 Digital I/O ports. When the test passes or fails, the corresponding Digital IO will output pulse signals to implement sorting or grading of products in the production line.



Histogram View

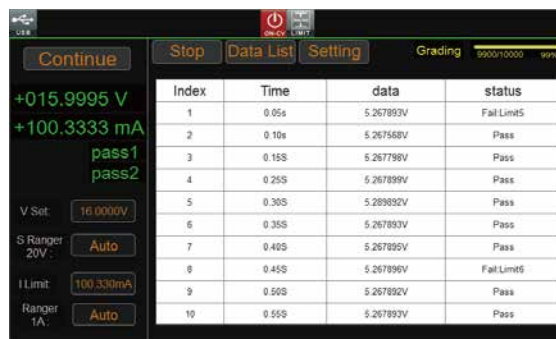

Table View

Your Power Testing Solution

IT2800 Graphical Source Measure Unit

4-wire ohmic measurement permits accurate low resistance measurement

When measuring small resistances the innate cable resistance can create serious measurement error. To solve this, the IT2800 Series supports a 4-wire measurement function. In the 4-wire scheme two of the connectors force current and the other two connectors measure voltage. Since the connectors measuring voltage do not have any current flowing through them, they can accurately sense the actual voltage at the DUT.

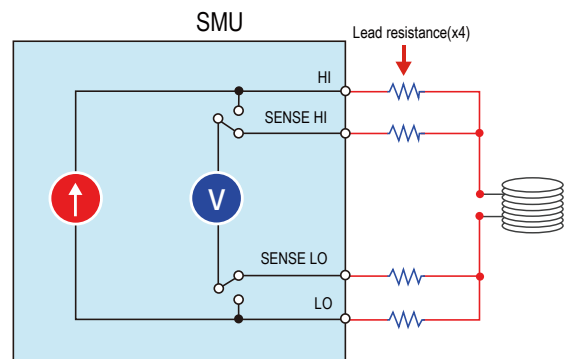

The application case

Resistivity is one of the important parameters of semiconductor materials. The resistivity of a single crystal material is a measure of the resistance of a charged carrier to flow through the material. It is closely related to the performance of semiconductor devices. For example, the breakdown voltage parameters of transistors are directly related to the resistivity of silicon single crystal. Four-probe method is a widely used standard test method, the main advantages of which are easy to operate, high accuracy and no strict requirements on the geometric size of the sample.

Battery simulator function enables more accurate analysis of low power consumption

Thanks to the four-quadrant operating characteristics of SMU, the IT2800 Series can not only be used as voltage source, current source, 6 ½ Digital Multimeter, but also built-in professional battery simulator function to help engineers better study the impact of battery characteristics on DUT power consumption and performance reliability.

You can quickly generate battery curves by customizing (SOC-VOC-R) or setting conventional parameters. In addition, the initial SOC state of the battery can be specified arbitrarily, without waiting for charging or discharging like using a real battery, which greatly improves the efficiency of R&D and production testing.



Large cache improves measurement throughput

For testing applications requiring high levels of automation and throughput, the IT2800 series SMU features a large cache. The Measure function can store up to 1 million points of output, and the source-measure measurement can store up to 1 million data points. Engineers can read the cache data in batches at the same time of measurement, so as to realize high-speed data acquisition and reduce the data transmission time in single instruction mode.

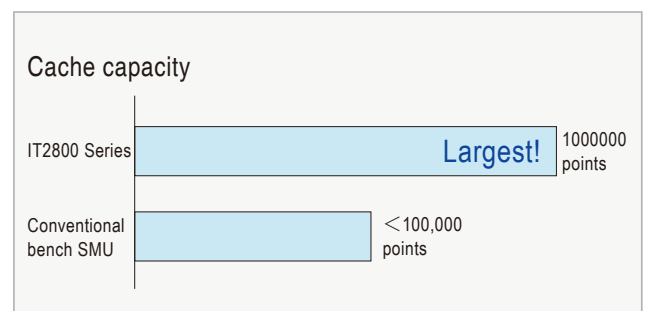

Your Power Testing Solution

IT2800 Graphical Source Measure Unit

Multi-channel cascade, easy to achieve parallel testing

The IT2800 series SMU offers multi-channel expansion applications that can connect up to 16 source meter units through fiber ports on the rear backplane to serve as a single, tightly synchronized, multi-channel system. Each channel instrument can run its own independent test sequence to achieve a fully multi-thread test which can meet advanced semiconductor test research as well as batch production line test applications.

Four quadrants and pulse output capability

The IT2800 Series SMU can operate in all four quadrants, where quadrant 1 & 3 are Source mode and quadrant 2 & 4 are Sink mode. The IT2800 Series features a 6 1/2 Digital Multimeter with up to 100nV/10fA resolution. The full range of models are available in DC and Pulse output modes. The IT2806 model also offers up to 10A pulse output capability, ideal for testing devices at the semiconductor wafer level, such as VCSEs, laser diodes, and LEDs, protecting DUTs.

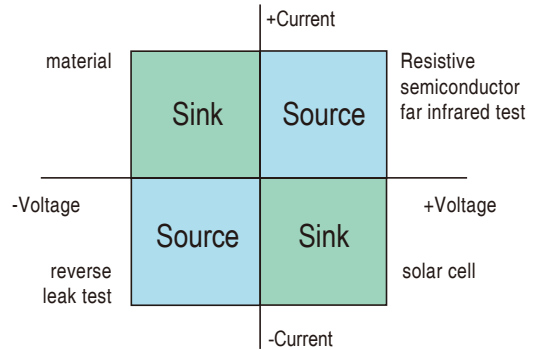

SMU

Four quadrant - source and sink

Professional I-V Characteristics Software and Semiconductor Parameters Testing Software

The I-V feature software provides a user-friendly GUI, which can be connected to a PC through the standard USB/LAN interface of the device for fast I-V measurement. The software provides multiple test function modules, including IV characteristic analysis, IV tracer, limit test, battery test and battery simulation, etc.

Semiconductor parameter testing software provides fast and powerful dynamic and static parameter testing solutions for semiconductors. The software presets various types of semiconductor devices, and users can quickly configure SMU by dragging. The graphical UI interface is simple and easy to operate, which accelerates the testing and research process of engineers.

I-V Characteristics Software 

Semiconductor Parameters Testing Software

Your Power Testing Solution

IT2800 Graphical Source Measure Unit

Optional accessories

Description	Model	
Banana to Triax adapter	IT-E801A	applied to IT2805, IT2806
	IT-E802A	applied to IT2801
Low leakage triax cable	IT-E801C-1.5	length: 1.5m, applied to IT2805, IT2806
	IT-E802C-1.5	length: 1.5m, applied to IT2801
Optional communication card	IT-E176	GPIB
Rack mount kit	IT-E158A	rack mount kit for two side-by-side installations in ITECH standard cabinets
	IT-E158B	rack mount kit for two side-by-side installations in non-ITECH standard cabinets
	IT-E158C	rack mount kit for single installation in ITECH standard cabinet
	IT-E158D	rack mount kit for single installation in non-ITECH standard cabinet
Kelvin(4 wires) testing line	IT-E601	300V pin type lead testing line, applied to IT2805, IT2806 pin(round) type lead
	IT-E601H	1000V pin type lead testing line, applied to IT2801 pin(round) type lead
	IT-E602	300V Large clip type lead applied to IT2805, IT2806 large clip type lead
	IT-E602H	300V Large clip type lead applied to IT2801 large clip type lead
	IT-E603	300V pin type lead testing line, applied to IT2805, IT2806 pin(conical) type lead
	IT-E603H	1000V pin type lead testing line, applied to IT2801 pin(conical) type lead
	IT-E604	pin type lead + Large clip type lead, applied to IT2805, IT2806
	IT-E604H	pin type lead + Large clip type lead, applied to IT2801
Optical fiber kit	IT-E168	for cascade between units, including fiber optic module and fiber optic harness (0.3m), fiber optic harness (1.5m)
Software	SPS5000	semiconductor parameter testing software (stay tuned)

Kelvin(4 wires) testing line

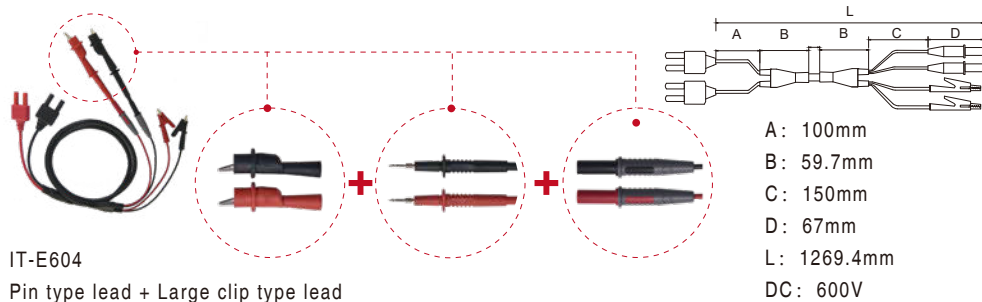

Your Power Testing Solution

IT2800 Graphical Source Measure Unit

Banana to triax adapter

Signal interference or excessive loop leakage current will lower the precision for ultra-low current measurement (below nA level). Therefore, it is necessary to ensure the measurement accuracy of extra low current through wiring protection. It requires to use the special triax cables. The IT2800 SMU provides a wealth of optional accessories banana-to-triax adapters and low-leakage triaxial cable accessories to meet the needs of ultra-low current measurement.

When used together, the guard conductor is at the same potential as the center conductor. Since there is no voltage difference, no current flows from the center conductor to the guard conductor, preventing leakage of current from affecting the test results.

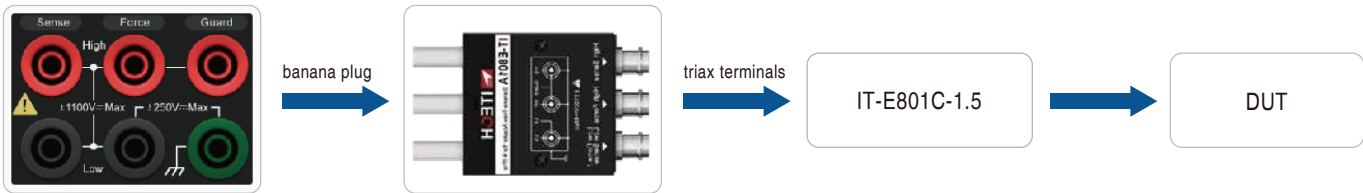

Software	
command	SCPI
communication interfaces	built-in USB/LAN, optional GPIB
control software	PV2800 I-V characteristic curve SPS5000 semiconductor parameter software (charged)
drive	IVI-C、IVI.NET and IVI-COM Driver, LabVIEW Driver

Dimension

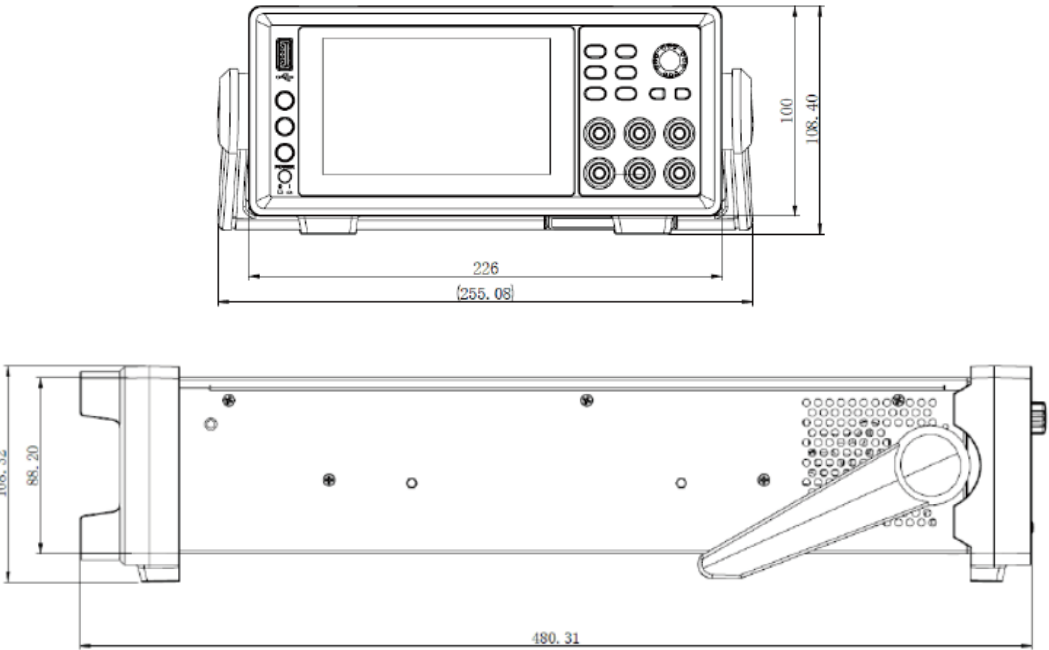

Your Power Testing Solution

IT2800 Graphical Source Measure Unit

IT2806 Basic Specification

Operating temperature	0-40 C
Operating altitude	0-2000M
AC input voltage	90-260V
AC input frequency	50/60Hz
Apparent power	250VA

Cooling	fan
Dimensions	450 mm (D) x 214 mm (W) x 88.2 mm(H)
Weight	6.7kg
Max. power	20W
Max. voltage	210V

Max. current	3.03ADC/10.5A Pluse
Communication interfaces	USB/LAN/GPIB(optional)
System bus	optical fiber
Input/output	DB25

Voltage and Current

	Voltage	Current
DC, pulse	200V	0.1A
	20V	1A
	6V	3A
Pulse	200V	1A
	12V	10A

Voltage precision

Range	Source/Measure resolution	Set precision	Measure precision	Noise p-p (< 10Hz)
±200mV	100nV	0.015%+300µV	0.015%+300µV	≤ 8µV
±2V	1µV	0.015%+300µV	0.015%+300µV	≤ 10µV
±20V	10µV	0.015%+1mV	0.015%+1mV	≤ 80µV
±200V	100µV	0.015%+10mV	0.015%+10mV	≤ 800µV

Current precision

Range	Source/Measure resolution	Set precision	Measure precision	Noise p-p (< 10Hz)
±10nA	10fA	0.1%+50pA	0.1%+50pA	≤ 2pA
±100nA	100fA	0.06%+100pA	0.06%+100pA	≤ 3pA
±1µA	1pA	0.025%+300pA	0.025%+300pA	≤ 10pA
±10µA	10pA	0.025%+700pA	0.025%+700pA	≤ 60pA
±100µA	100pA	0.02%+6nA	0.02%+6nA	≤ 600pA
±1mA	1nA	0.02%+60nA	0.02%+60nA	≤ 6nA
±10mA	10nA	0.02%+600nA	0.02%+600nA	≤ 60nA
±100mA	100nA	0.02%+6µA	0.02%+6µA	≤ 600nA
±1A	1µA	0.05%+500µA	0.05%+500µA	≤ 10µA
±3A	10µA	0.05%+1.5mA	0.05%+1.5mA	≤ 30µA
±10A *1	10µA	0.4%+25mA *2	0.4%+25mA *2	-

*1 Pulse mode

*2 Measure speed 0.01PLC

Resistance(4-wire connection, 2V)

Range	Resolution	Measure current	Current range	Measure precision
2Ω	1uΩ	1A	1A	0.1%+300uΩ
20Ω	10uΩ	100mA	100mA	0.055%+3mΩ
200Ω	100uΩ	10mA	10mA	0.055%+30mΩ
2KΩ	1mΩ	1mA	1mA	0.055%+300mΩ
20KΩ	10mΩ	100uA	100uA	0.055%+3Ω
200KΩ	100mΩ	10uA	10uA	0.055%+30Ω
2MΩ	1Ω	1uA	1uA	0.07%+300Ω
20MΩ	10Ω	100nA	100nA	0.2%+3kΩ
200MΩ	100Ω	10nA	10nA	0.7%+30kΩ

Parameters as a pulse source

Min. pulse width: 100us | Set pulse resolution: 10us

	Max. voltage	Peak current	Offset value	Max. pulse width	Max. duty cycle
DC pulse	6V	3A	3A	no limit	100%
	20V	1A	1A	no limit	100%
	200V	0.1A	0.1A	no limit	100%
Pulse	12V	10A	0.5A	1ms	2.50%
	200V	1A	50mA	2.5ms	2.50%

PLC derating accuracy (% of additional range)

PLC	200mV	2V	20V-200V
0.1PLC	0.01%	0.005%	0.005%
0.01PLC	0.05%	0.01%	0.01%
0.001PLC	0.3%	0.1%	0.1%

PLC	10nA	100nA	1uA-10uA	100uA-100mA	1A-3A
0.1PLC	0.30%	0.03%	0.01%	0.01%	0.01%
0.01PLC	1.00%	0.10%	0.05%	0.02%	0.03%
0.001PLC	3.00%	1.00%	0.30%	0.20%	0.20%

Other parameters

Temperature Coefficient (0°C~18°C and 28°C~50°C)	±0.15x precision/°C
Voltage output noise (10Hz-20MHz)	30mVp-p /4mVrms (≤1ARange)
Voltage output stabilization time	Time required to be not more than 0.1% of final value under open circuit conditions, the step is 10%~90% of the range 200mV range: <100uS (3ARange) 2V range: <120uS (3ARange) 20V range: <250uS (1ARange) 200V range: <400uS (100mARange)
Current output stabilization time	Time required to be not more than 0.1% of the final value under short-circuit conditions, the step is 10%~90% of the range 100nA range: <5mS 1uA range: <600uS 10uA range: <350uS 100uA range: <200uS 1mA range: <150uS 10mA range: <150uS 100mA range: <150uS 1A range: <300uS 3A range: <80uS
Voltage source overshoot	<(0.1%+10mV). The step is 10%~90% of the range, resistive load
Current source over shoot	<0.1%. The step is 10%~90% of the range, resistive load
Voltage source overshoot when range changes	<250mV. 100K load, 20MHz bandwidth
Current source over shoot when range changes	<250mV/R load, 20MHz bandwidth
Maximum capacitive load	0.01uF (normal mode) 50uf (high capacitance mode)
DC floating voltage	Force-Maximum voltage between output and the ground is ±250V DC
GUARD (offset voltage protection)	<1mV
GUARD (output impedance)	>10KΩ Typical
Common mode isolation	>1GΩ, <4700pF
Max. voltage difference between sense and local voltage	4V

Your Power Testing Solution

IT2800 Graphical Source Measure Unit

IT2805 Basic Specification

Operating temperature	0-40 C
Operating altitude	0-2000M
AC input voltage	90-260V
AC input frequency	50/60Hz
Apparent power	250VA

Cooling	fan
Dimensions	450 mm (D) x 214 mm (W) x 88.2 mm(H)
Weight	6.7kg
Max. power	20W
Max. voltage	210V

Max. current	1.515A
Communication interfaces	USB/LAN/GPIB(optional)
System bus	optical fiber
Input/output	DB25

Voltage and Current

	Voltage	Current
DC, pulse	200V	0.1A
	20V	1A
	6V	1.5A

Voltage precision

Range	Set resolution	Set precision	Measure resolution	Measure precision	Noise p-p (< 10Hz)
±200mV	1μV	0.015%+300μV	100nV	0.015%+300μV	≤ 8μV
±2V	10μV	0.015%+300μV	1μV	0.015%+300μV	≤ 10μV
±20V	100μV	0.015%+1mV	10μV	0.015%+1mV	≤ 80μV
±200V	1mV	0.015%+10mV	100μV	0.015%+10mV	≤ 800μV

Current precision

Range	Set resolution	Set precision	Measure resolution	Measure precision	Noise p-p (< 10Hz)
±10nA	100fA	0.1%+50pA	10fA	0.1%+50pA	≤ 2pA
±100nA	1pA	0.06%+100pA	100fA	0.06%+100pA	≤ 3 pA
±1μA	10pA	0.025%+300pA	1pA	0.025%+300pA	≤ 10pA
±10μA	100pA	0.025%+700pA	10pA	0.025%+700pA	≤ 60pA
±100μA	1nA	0.02%+6nA	100pA	0.02%+6nA	≤ 600pA
±1mA	10nA	0.02%+60nA	1nA	0.02%+60nA	≤ 6nA
±10mA	100nA	0.02%+600nA	10nA	0.02%+600nA	≤ 60nA
±100mA	1μA	0.02%+6μA	100nA	0.02%+6μA	≤ 600nA
±1A	10μA	0.05%+500μA	1μA	0.05%+500μA	≤ 10μA
±1.5A	10μA	0.05%+1.5mA	1μA	0.05%+1.5mA	≤ 30μA

Resistance(4-wire connection,2V)

Range	Resolution	Measure current	Current range	Measure precision
2Ω	1uΩ	1A	1A	0.1%+300uΩ
20Ω	10uΩ	100mA	100mA	0.055%+3mΩ
200Ω	100uΩ	10mA	10mA	0.055%+30mΩ
2KΩ	1mΩ	1mA	1mA	0.055%+300mΩ
20KΩ	10mΩ	100uA	100uA	0.055%+3Ω
200KΩ	100mΩ	10uA	10uA	0.055%+30Ω
2MΩ	1Ω	1uA	1uA	0.07%+300Ω
20MΩ	10Ω	100nA	100nA	0.2%+3kΩ
200MΩ	100Ω	10nA	10nA	0.7%+30kΩ

Parameters as a pulse source

Min. pulse width : 100us | Set pulse resolution : 10us

	Max. voltage	Peak current	Offset value	Max. pulse width	Max. duty cycle
DC pulse	6V	1.5A	1.5A	no limit	100%
	20	1A	1A	no limit	100%
	200	0.1A	0.1A	no limit	100%

PLC derating accuracy (% of additional range)

PLC	200mV	2V	20V-200V
0.1PLC	0.01%	0.005%	0.005%
0.01PLC	0.05%	0.01%	0.01%
0.001PLC	0.30%	0.10%	0.10%

PLC	10nA	100nA	1uA-10uA	100uA-100mA	1A-1.5A
0.1PLC	0.30%	0.03%	0.01%	0.01%	0.01%
0.01PLC	1.00%	0.10%	0.05%	0.02%	0.03%
0.001PLC	3.00%	1.00%	0.30%	0.20%	0.20%

Other parameters

Temperature Coefficient (0 C ~18 C and 28 C ~50 C)	±0.15x precision/ C
Voltage output noise (10Hz~20MHz)	30mVp-p /4mVrms (≤ 1ARange)
Voltage output stabilization time	Time required to be not more than 0.1% of final value under open circuit conditions, the step is 10%~90% of the range 200mV range: <100uS (1.5ARange) 2V range: <120uS (3ARange) 20V range: <250uS (1ARange) 200V range: <400uS (100mARange)
Current output stabilization time	Time required to be not more than 0.1% of the final value under short-circuit conditions, the step is 10%~90% of the range 100nA range: <5mS 1uA range: <600uS 10uA range: <350uS 100uA range: <200uS 1mA range: <150uS 10mA range: <150uS 100mA range: <150uS 1A range: <300uS 1.5A range: <100uS
Voltage source overshoot	<(0.1%+10mV). The step is 10%~90% of the range, resistive load
Current source over shoot	<0.1%. The step is 10%~90% of the range, resistive load
Voltage source overshoot when range changes	<250mV. 100K load, 20MHz bandwidth
Current source over shoot when range changes	<250mV/R load, 20MHz bandwidth
Maximum capacitive load	0.01uF (normal mode) 50uf (high capacitance mode)
DC floating voltage	Force-Maximum voltage between output and the ground is ±250V DC
GUARD (offset voltage protection)	<1mV
GUARD (output impedance)	>10KΩ Typical
Common mode isolation	>1GΩ, <4700pF
Max. voltage difference between sense and local voltage	4V

Your Power Testing Solution

IT2800 Graphical Source Measure Unit

IT2801 Basic Specification

Operating temperature	0-40 C
Operating altitude	0-2000M
AC input voltage	90-260V
AC input frequency	50/60Hz
Apparent power	250VA

Cooling	fan
Dimensions	450 mm (D) x 214 mm (W) x 88.2 mm(H)
Weight	6.7kg
Max. power	20W
Max. voltage	1050V

Max. current	1.05A
Communication interfaces	USB/LAN/GPIB(optional)
System bus	optical fiber
Input/output	DB25

Voltage power source

Range	Source/Measure resolution	Set precision	Measure precision	Noise p-p (< 10Hz)
±200mV	100nV	0.015%+300µV	0.015%+300µV	≤ 25µV
±2V	1µV	0.015%+300µV	0.015%+300µV	≤ 25µV
±20V	10µV	0.015%+1mV	0.015%+1mV	≤ 200µV
±200V	100µV	0.015%+10mV	0.015%+10mV	≤ 2mV
±1000V	1mV	0.02%+50mV	0.02%+50mV	≤ 10mV

Current power source

Range	Source/Measure resolution	Set precision	Measure precision	Noise p-p (< 10Hz)
±1µA	1pA	0.025%+300pA	0.025%+300pA	≤ 8pA
±10µA	10pA	0.025%+700pA	0.025%+700pA	≤ 80pA
±100µA	100pA	0.025%+6nA	0.025%+6nA	≤ 800pA
±1mA	1nA	0.025%+60nA	0.025%+60nA	≤ 8nA
±10mA	10nA	0.025%+600nA	0.025%+600nA	≤ 80nA
±100mA	100nA	0.025%+6µA	0.025%+6µA	≤ 800nA
±1A	1µA	0.03%+500µA	0.03%+500µA	≤ 30uA

Resistance(4-wire connection,2V)

Range	Resolution	Measure current	Current range	Measure precision
2Ω	1uΩ	1A	1A	0.1%+300uΩ
20Ω	10uΩ	100mA	100mA	0.055%+3mΩ
200Ω	100uΩ	10mA	10mA	0.055%+30mΩ
2KΩ	1mΩ	1mA	1mA	0.055%+300mΩ
20KΩ	10mΩ	100uA	100uA	0.055%+3Ω
200KΩ	100mΩ	10uA	10uA	0.055%+30Ω
2MΩ	1Ω	1uA	1uA	0.07%+300Ω
20MΩ	10Ω	100nA	1uA	0.35%+3kΩ

PLC derating accuracy (% of additional range)

PLC	1uA-10uA	100uA-100mA	1A	200mV	2V	20V-1000V
0.1PLC	0.01%	0.01%	0.02%	0.02%	0.01%	0.01%
0.01PLC	0.08%	0.05%	0.03%	0.05%	0.05%	0.02%
0.001PLC	0.50%	0.5%	0.20%	0.20%	0.10%	0.05%

Parameters as a pulse source

Min. pulse width: 100us | Set pulse resolution: 10us

	Max. voltage	Peak current	Offset value	Max. pulse width	Max. duty cycle
DC pulse	20V	1A	1A	no limit	100%
	200V	0.1A	0.1A	no limit	100%
	1000V	0.01A	0.01A	no limit	100%

Other parameters

Temperature Coefficient (0°C~18°C and 28°C~50°C)	±0.15x precision/°C
Voltage output noise (10Hz~20MHz)	30mV p-p, 3mV rms
Voltage output stabilization time	Time required to be not more than 0.1% of final value under open circuit conditions, the step is 10%~90% of the range 200mV range: <450uS 2V range: <700uS 20V range: <250uS 200V range: <300uS 1000V range: <5mS
Slew rate	no load, the step is 10%~90% of the range 200mV range: 2mV/uS 2V range: 20mV/uS 20V range: 200mV/uS 200V range: 1.8V/uS 1000V range: 1V/uS
Current output stabilization time	Time required to be not more than 0.1% of the final value under short-circuit conditions, the step is 10%~90% of the range 1uA range: <1.5mS 10uA range: <1mS 100uA range: <300uS 1mA range: <300uS 10mA range: <300uS 100mA range: <300uS 1A range: <300uS
Voltage source overshoot	<(0.1%+10mV). The step is 10%~90% of the range, resistive load
Current source over shoot	<0.1%. The step is 10%~90% of the range, resistive load
Voltage source overshoot when range changes	<250mV. 100K load, 20MHz bandwidth
Current source over shoot when range changes	<250mV/R load, 20MHz bandwidth
Maximum capacitive load	0.01uF
DC floating voltage	Force-Maximum voltage between output and the ground is ±250V DC
GUARD (offset voltage protection)	<1mV
GUARD (output impedance)	>10KΩ Typical
Common mode isolation	>1GΩ, <4700pF
Max. voltage difference between sense and local voltage	4V

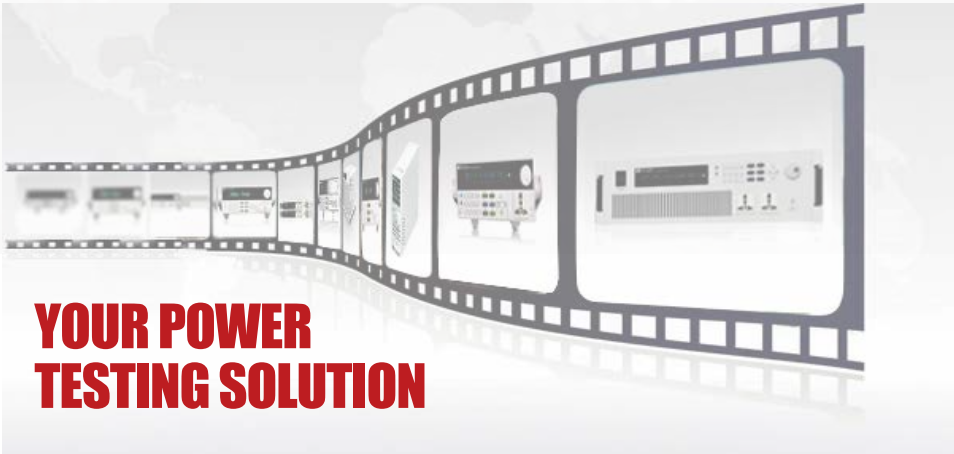
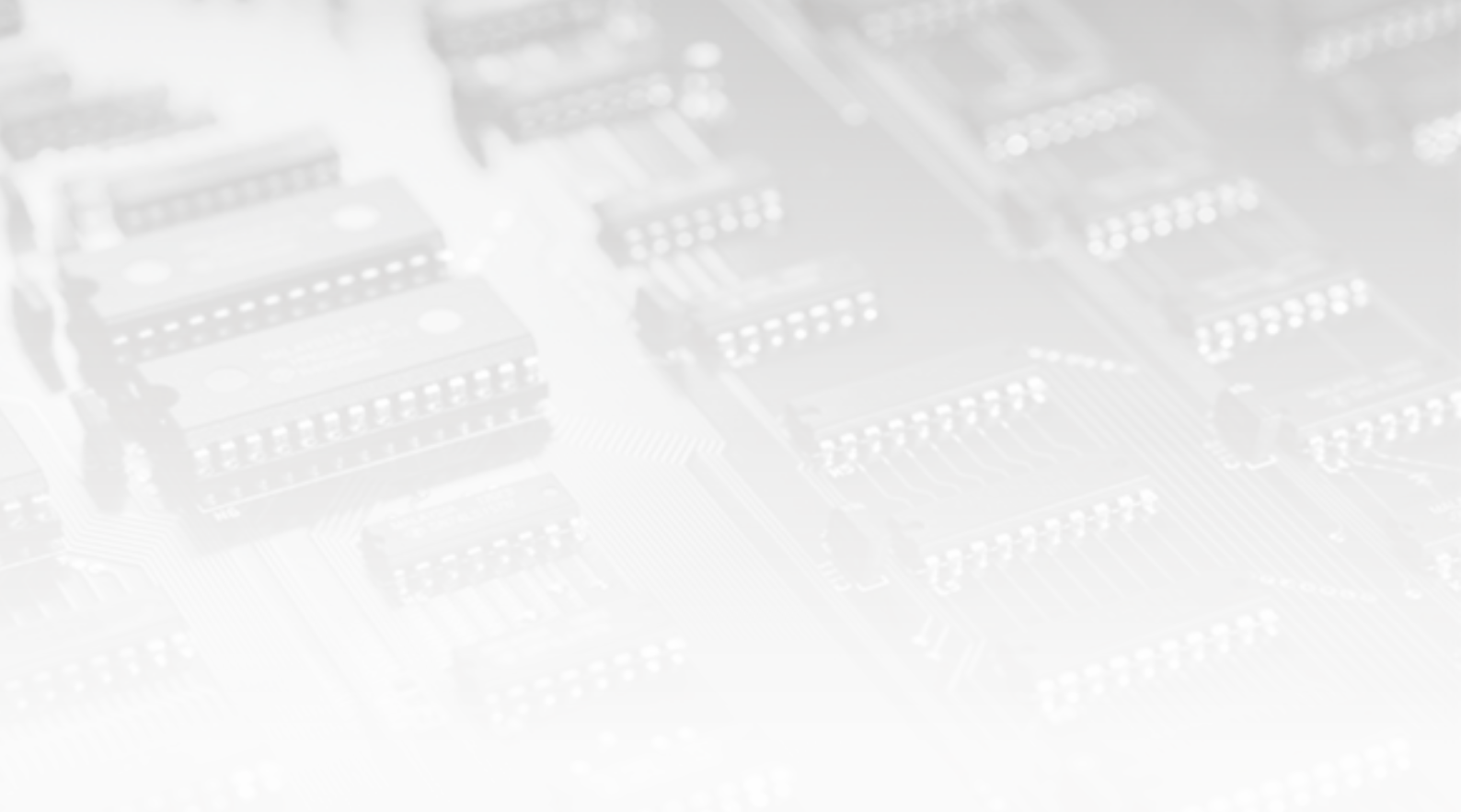

YOUR POWER TESTING SOLUTION

This information is subject to change without notice. For more information, please contact ITECH.

Taipei

Add: No.918, Zhongzheng Rd., Zhonghe Dist., New Taipei City
235, Taiwan
Web: www.itechate.com
TEL: +886-3-6684333
E-mail: info@itechate.com

Factory I

Add: No.108, XiShanqiao Nanlu, Nanjing city, 210039, China
TEL: +86-25-52415098
Web: www.itechate.com

Factory II

Add: No.150, Yaonanlu, Meishan Cun, Nanjing city, 210039, China
TEL: +86-25-52415099
Web: www.itechate.com



ITECH Web



ITECH Facebook



ITECH LinkedIn