



Next generation in precision

WT5000 Precision Power Analyzers

Precision Making

Bulletin WT5000-01EN



As renewable energy, electric vehicles, and energy efficient technologies gain wider adoption, the need for reliability in testing efficiency, performance, and safety has never been greater.

Changing application needs and evolving international standards call for custom measurements and consistent accuracy. With the WT5000 Precision Power Analyzer, engineers have a versatile platform that not only delivers reliable measurements today but is ready for the challenges of tomorrow.

With its unmatched accuracy and modular architecture, the WT5000 empowers engineers to innovate with precision, flexibility, and confidence to quickly bring their products from concept to market.

The WT5000 delivers:

Reliability – With a guaranteed accuracy of $\pm 0.03\%$, harmonic comparisons up to the 500th order, and custom computations, the WT5000 delivers multichannel measurements that everyone can trust.

Versatility – Seven slots for user-swappable power elements and diverse options enable expansion and reconfiguration of the WT5000 as application needs change. Additionally, the speed and torque from four separate motors can be measured.

Simplicity – With a full touchscreen experience, supported by hardware hotkeys and powerful software for remote measurements, connecting, configuring, and measuring power has never been easier.



Precision at the fingertips

Multi-channel measurements

Measure from up to seven different power phases at 10 MS/s (18 bits). The high resolution, 10.1 inch WXGA display allows split screen viewing of up to seven waveforms and can display up to 12 pages of diverse measurement parameters, making it ideal for efficiency tests of inverter-driven motors, renewable energy technologies, and traction applications such as pumps, fans, and electric vehicles. Measurements are also displayed in vector format or trending in time.

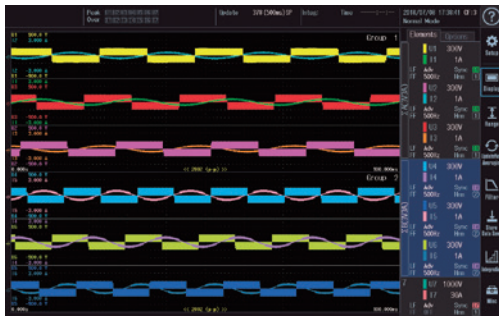

Intuitive operation

Operable by touch and/or hardware hotkeys independently, the WT5000 offers a seamless and intuitive experience that makes connecting, configuring, and measuring easier than ever before. The 10.1 inch WXGA touchscreen delivers excellent noise immunity even in high-noise environments such as motors and inverters.



Unmatched accuracy

The WT5000 is the world's most accurate precision power analyzer with a basic power accuracy of $\pm 0.03\%$. Its accuracy specifications are guaranteed from 1% to 130% of the selected voltage and current ranges. With minimum influence of low-power factor (0.02% of apparent power) the unit is also accurate at large phase shifts and frequencies.

- AC power accuracy: 0.01% of reading + 0.02% of range
- DC power accuracy: 0.02% of reading + 0.05% of range
- 10 MS/s 18 bit ADC

Custom triggers and computations

Define and use event triggers and custom computations as per application needs. The event trigger function allows users to set limits to capture readings that fall within or outside a specific range of power, current, or other parameters. Users can also define and use up to 20 different expressions for custom calculations. Data that meets the trigger conditions can be stored, printed, or saved to a USB memory device.

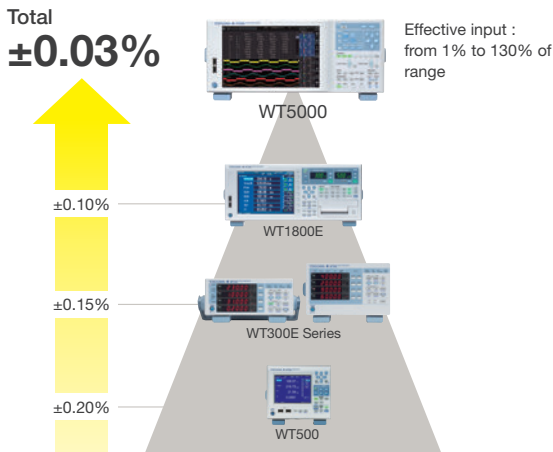

User Defined Functions				
	F1-F5	F6-F10	F11-F15	F16-F20
	Name	Expression	Unit	
F1	OFF	Avg-W	#(E1)/(TIME1)/3600	W
F2	OFF	P-loss	PE1-PE2	W
F3	OFF	U-ripple	(UPK(E1)-UMK(E1))/2/DC(E1)*100	%
F4	OFF	I-ripple	(IPK(E1)-IMK(E1))/2/DC(E1)*100	%
F5	OFF	D-timeR	DELTAURMS(SA)	V

User-defined function

Advanced filtering

In addition to low pass frequency filters and line filters, the WT5000 features advanced filtering capabilities that provide unprecedented control to analyze even the toughest of waveforms with precision.

- Synchronization source filter: Instead of synchronizing to zero-crossings, users can select any specific point of the synchronization source signal.
- Enhanced frequency filter: Allows users to simultaneously measure fundamental and switching frequencies without influencing any other parameter.
- Digital parallel path filters: Supported by a high-frequency anti-aliasing filter, two separate line filters for normal and harmonic measurements ensure accuracy without aliasing in wideband and harmonic measurements. Users can limit the number of harmonic orders to eliminate attenuation in low-bandwidth measurements.









Advanced harmonic analysis

Evaluate and compare input and output harmonics of inverters, motors, or power conditioners up to the 500th order. The WT5000 allows users to not only measure harmonics and power simultaneously but also offers side-by-side comparison of harmonics from two different input sources.

The effects of noise and aliasing are minimized by anti-aliasing and line filters with Digital Parallel Path technology, allowing simultaneous power analysis of wide-band and narrow-band components.



Precision measurements for every application

Field	Application purpose	Measurement parameters
Electric vehicles 	Powertrain efficiency Motor evaluation Battery charging/discharging	DC and AC power parameters, torque, speed electrical, mechanical and overall efficiency, power consumption, and loss
Renewable energy 	Power conditioner evaluation Maximum power point tracking Harmonic analysis	Boost converter and inverter efficiency Battery voltage, motor rotation pulse Harmonic distortion factor, ripple factor
Industrial robotics 	Power consumption analysis, Operation and standby mode testing Transient power analysis	Efficiency, duty cycle Sensor receiving wave, receiving pulse
Home and office appliances 	Standby power testing Lighting – switching and PWM modulation	AC power, voltage, current at standby and operation modes Average active power
Transformer testing 	Loss measurement and short circuit testing	AC power, low-power factor
Healthcare and medical equipment 	Power consumption measurement to guarantee quality	Low- and high-frequency power measurement

Precision made easy



1 Peripheral device connection

Two USB ports for connection to storage, keyboard, mouse, etc.

2 10.1 inch WXGA touch screen

A 10.1 inch resistive touch screen delivers excellent noise immunity performance even in environments with high electrical noise such as motors and inverters.

3 Display format setting

Comprehensive range of display functions for power analysis, including numeric/waveform/vector/bar.

4 Input element and range setting keys

Set the voltage and current ranges on up to seven input elements.

5 Store and integration function key

Store and Integration function setting and execution key.

6 Communication functions

USB (3.0), Ethernet (VXI-11), and GP-IB.

7 Connectors for multi-unit synchronization

One main (master) unit and three sub (slave) units, a total of four units can be connected.

8 RGB output

Video signal output for 1280 × 800 WXGA high-resolution RGB display

9 30 A input element

High-accuracy element, from 0.5 to 30 A direct current and 1.5 to 1000 V direct voltage input. 1500 Vdc can be measured.*¹ Users can install, remove or swap these input elements themselves.

10 5 A input element

High-accuracy element, from 5 mA to 5 A direct current and 1.5 to 1000 V direct voltage input. 1500 Vdc can be measured.*¹ Users can install, remove or swap these input elements themselves.

11 Current sensor element

High-accuracy element, built-in DC power supply, enables both easy wiring and reliable high-precision, large-current measurements. 1500 Vdc can be measured.*¹ Users can install, remove or swap these input elements themselves.

12 Motor evaluation function 1 (optional)

Select Torque (Pulse/Analog) and A/B/Z (Pulse) inputs or two sets of Torque (Pulse/Analog) and A (Pulse) inputs.

13 Motor evaluation function 2 (optional)

Select Torque (Pulse/Analog) and A/B/Z (Pulse) inputs or two sets of Torque (Pulse/Analog) and A (Pulse) inputs.

*1: Use cables and terminals adaptable to high voltages up to 1500 Vdc.



9

10

11



The direct input terminal adopted male type large safety terminals prevent any mistakes as voltage input terminals. A dedicated safety terminal adapter set is attached as standard.

Easy wiring and reliable high-precision large current measurements by using the current sensor element.



Customize/configure the test bench

Evaluate motors, drives, and inverters

Measure more than just electrical parameters. The motor evaluation function enables measurements of rotational speed and direction, synchronous speed, slip, torque, mechanical power, electrical angle, and motor efficiency from an analog or pulse output of torque sensors or pulse outputs of rotation sensors.

Up to two motors can be measured per WT5000 when the determination of the rotation direction and the electrical angle is needed. A simple setting in the motor configuration menu allows a single WT5000 to take synchronous measurements from up to four torque and rotation sensors, enabling users to determine the overall efficiency from four-wheel driven vehicles.

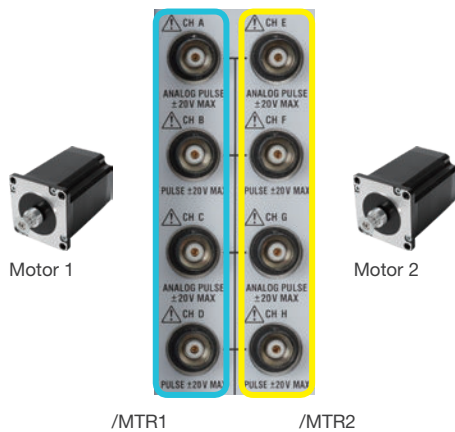

A single WT5000 configured for simultaneous, synchronized measurements from two motors to determine torque, rotation speed, direction, and electrical angles of A/B and Z phases.

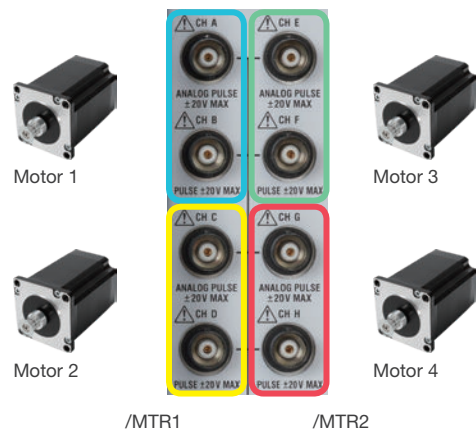

A single WT5000 configured for simultaneous synchronized measurements from four torque and rotation sensors to determine overall efficiency of four motors.

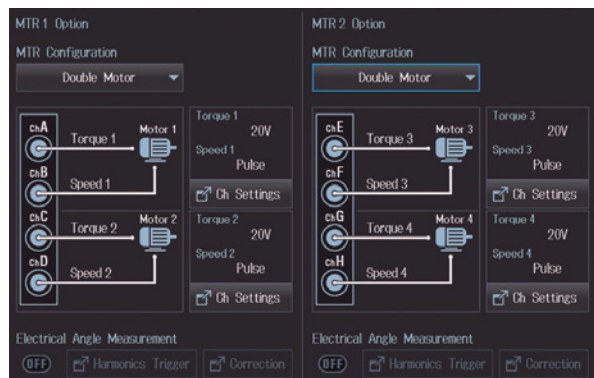
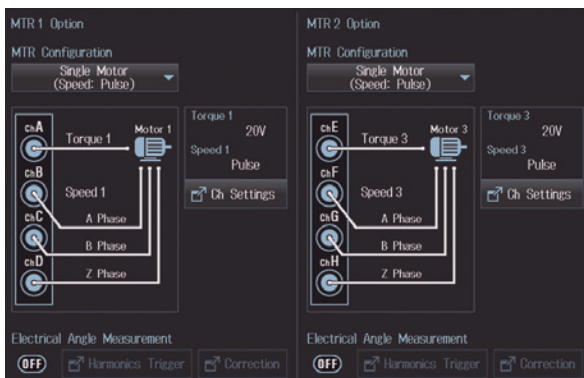

Use /MTR1 and /MTR2 options together to measure up to four motors simultaneously.

Up to 32 GB of internal memory

The WT5000 offers up to 32 GB of internal storage memory that can be used to store and recall various custom configurations and test setups. It can also be used to log large amounts of measurement data over long periods of time, behaving just like a logger. This large non-volatile memory makes it easy to store data without preparing any external media. Save Waveform/ Numeric/Screen Copy data or Setting Information.

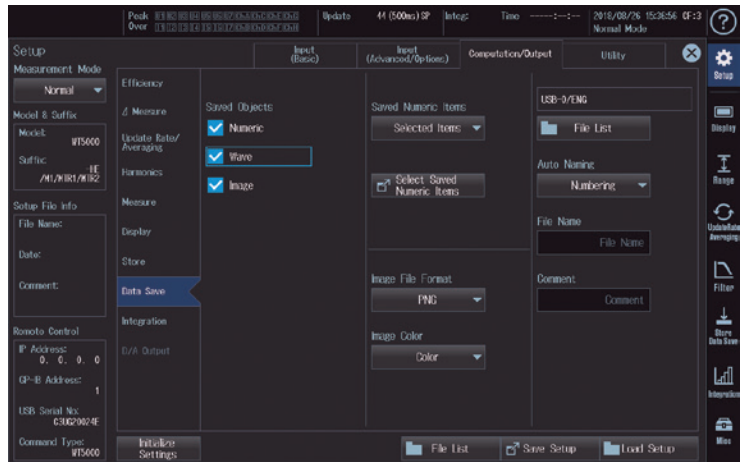
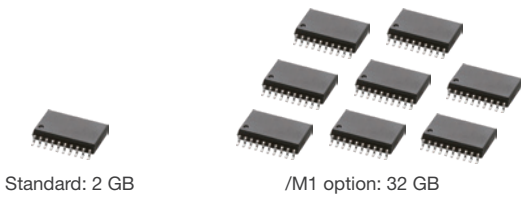

Communications

Not only does the WT5000 support GP-IB, USB, and Ethernet communications, it is also backward compatible with communication commands of previous models.

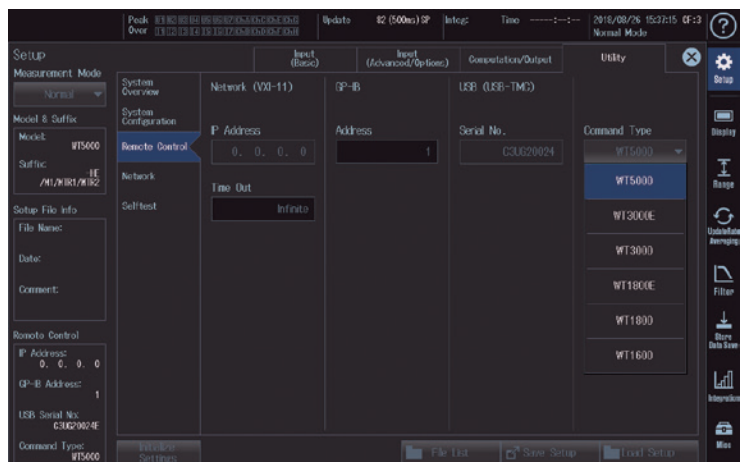

Extend measurements with multi-unit synchronization

When synchronizing four WT5000s with one main unit and three sub units, there is access to 28 input elements for electrical power measurements and up to 16 motor evaluation functions. The WTViewerE software supports this performance.

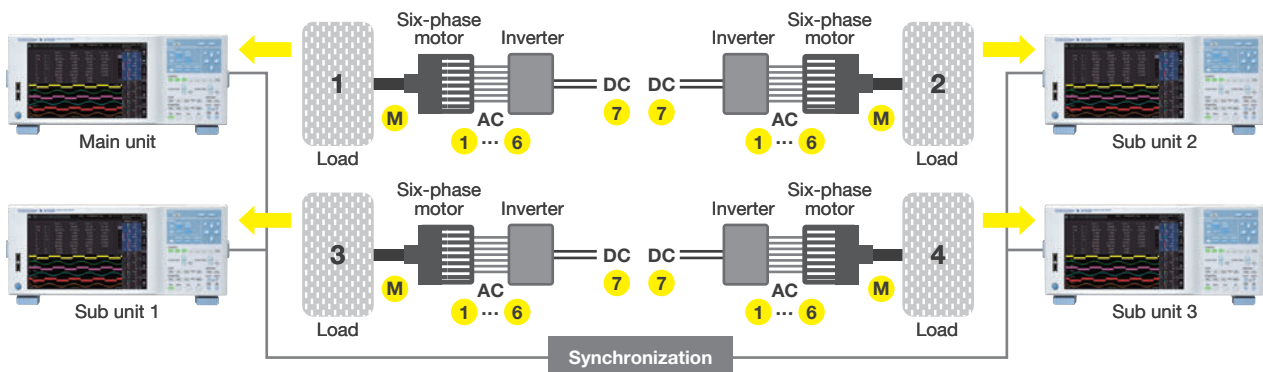

Raw waveform data streaming

In addition to benefitting from the highly accurate numerical data measured by the WT5000, one can stream to a PC the raw waveform data with a sample speed of up to 2 MS/s. Voltage and current waveforms as well as the motor signals can be streamed to a PC. This allows engineers to study the transient behavior simultaneously when measuring efficiency or energy consumption.

The raw waveform data is streamed without any gaps, can be combined, and is synchronized with the numerical data. Abnormal findings in numerical data can be directly linked and evaluated in the waveform data. For example, one can find numeric parameters variation caused by the influence of imposed high-frequency noise.

To stream the raw waveform data to a PC, it is possible to make use of IS8000. This can also be done by making use of dedicated communication commands for programming.

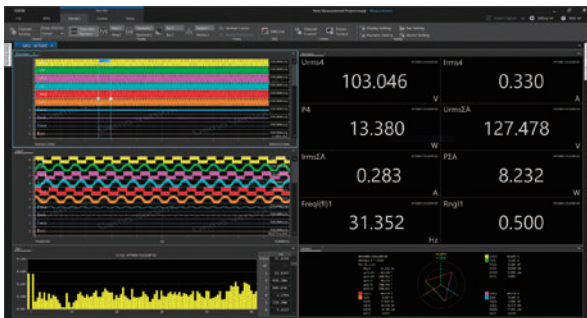

Display examples of IS8000

Maximum waveform trace count

Sample rate (S/s)	Maximum waveform trace count	
	USB 3.0	Gigabit Ethernet (VXI-11)
2 M	2	2
1 M	6	4
500 k	14	6
10 k to 200 k	22	22

Automatic change of calculation period according to input frequency

Auto update mode can measure power at the fastest interval of 10 ms and automatically change the update interval as the frequency changes. This feature allows reliable power measurement without gaps even when a motor is accelerated or decelerated in motor evaluation. It can cover frequencies as low as 0.1 Hz, and stable measurement results can be obtained even when the motor rotates at low speed.

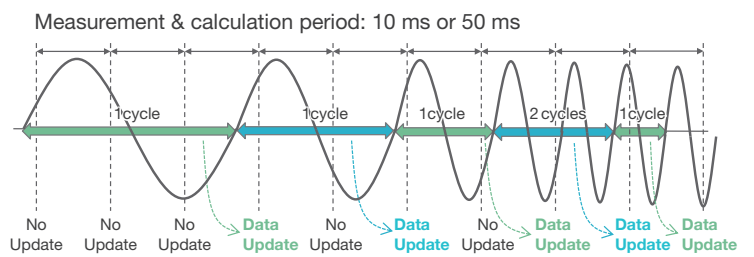
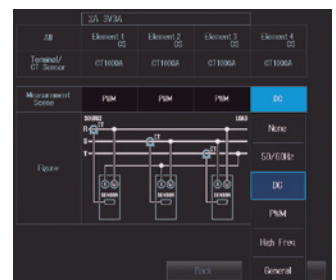

Image of operation in auto update mode

Easy setup menu

Setting items such as measurement range and filter can be easily configured according to a measurement scene.

After selecting a measurement scene, the setting items can be checked at a glance, making it easy to adjust the setting values.



Selection of measurement scene

Current sensor module with DC power supply

Use of the internal DC power supply for AC/DC current sensors simplifies the preparations before measurement and the measurement setup only requires the current sensor and a connecting cable. Using an external DC power supply and additional wiring is no longer required. There are three sensor connection cable lengths available; i.e., 3 m, 5 m, and 10 m.

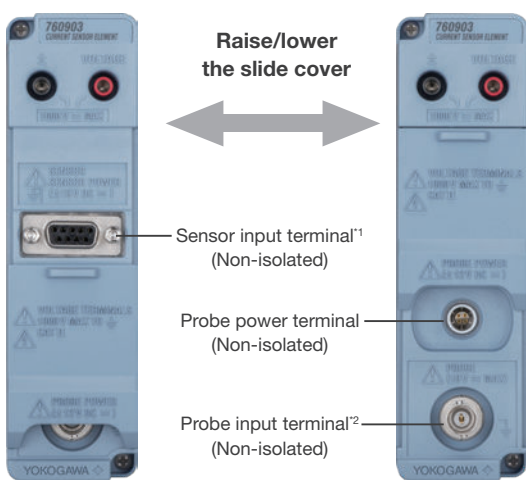

*1: The following AC/DC current sensors are available: CT60, CT200, CT1000, CT1000A, CT2000A

*2: The following current clamp probes are available: 720930, 720931

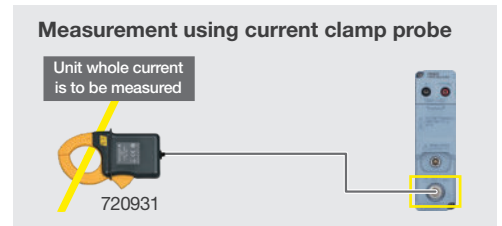
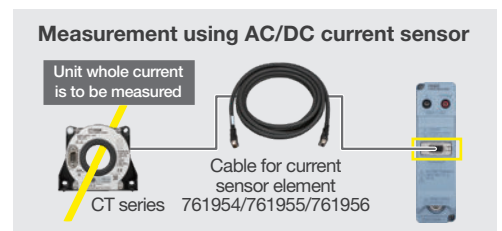

Characteristic example of the current sensor element

*These only shows 760903 current sensor element's characteristic.

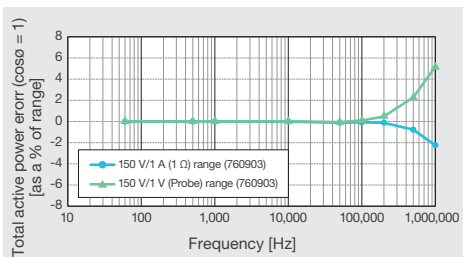

Frequency versus power accuracy at unity power factor

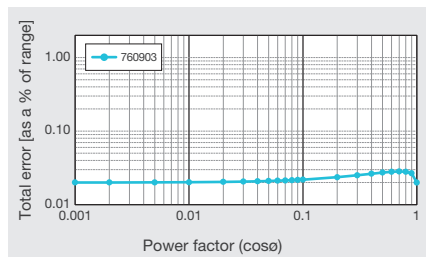

Total power error with rated range input for an arbitrary power factor (50/60 Hz)

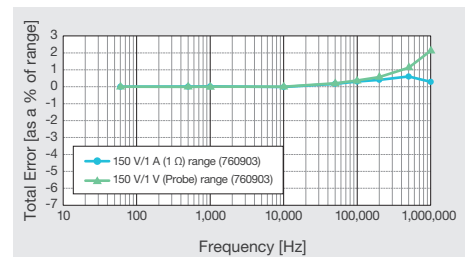

Frequency versus power accuracy at zero power factor

Phase correction

The WT5000 offers gain and phase correction functions for precision power measurement. In some applications, external sensors and probes are required to enable high-current measurement. In order to maximize accuracy during measurement, it is recommended to correct gain and phase error or calibrate the measurement setup.

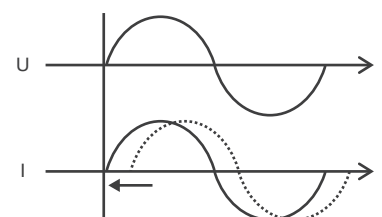

Image of phase shift of waveform

Next generation in precision

Having worked with engineers in the areas of R&D, production, QA, and field testing, Yokogawa Test&Measurement recognizes the importance of reliable and precise measurements for making critical decisions in product development and compliance. For more than 100 years, we have pushed the limits of measurement accuracy and integrity with every generation of our measurement technologies.

The WT5000 ushers in a new era of precision power measurements that provides engineers with the accuracy and confidence to keep up with evolving international standards, as well as the flexibility to adapt to ever changing application needs. Combining the very best in isolation, noise immunity, current sensing, and filtering in a modular architecture, the WT5000 is an extensible measurement platform that unlocks precision power analysis for electromechanical systems in electric vehicles, renewable energy, industrial equipment, and home and office appliances.

Precision current sensing – The coaxial construction of current shunts in the swappable 30 A input element ensures low resistance, low inductance, low impact on phase shift, and minimizes heat dissipation. Heat flow pathways are optimized in the shunts and across the instrument to ensure even distribution and minimum effect on resistance.

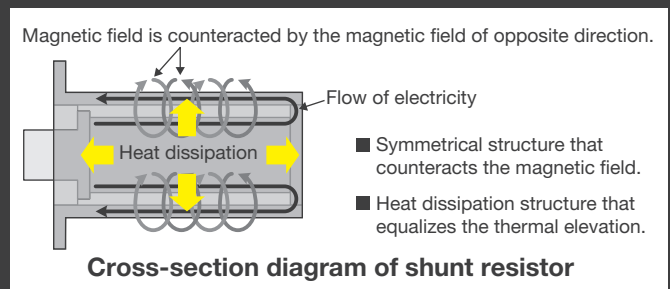

Advanced filtering – Whether it is for custom synchronization of measurements, smoothing of signal fluctuations, or simultaneous wideband and harmonic power analysis, the advanced filtering options of the WT5000 put the user in control of measurements without compromising on accuracy.

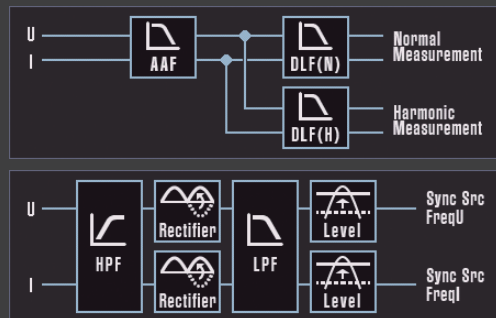

Noise and isolation – Special shielding and optical transmission protect against noise and crosstalk. Yokogawa isoPRO technology ensures fast data transmission (maximum 10 MS/s) and industry-leading isolation to the input elements. It is designed particularly for energy-saving applications, at high voltage, large currents and high frequency. Noise flow routes are optimized for minimum effect on the measurement circuitry.

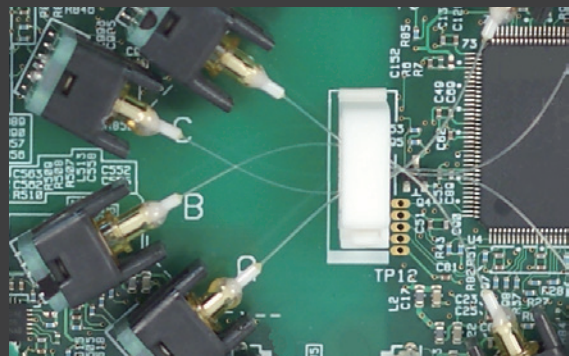

Applications

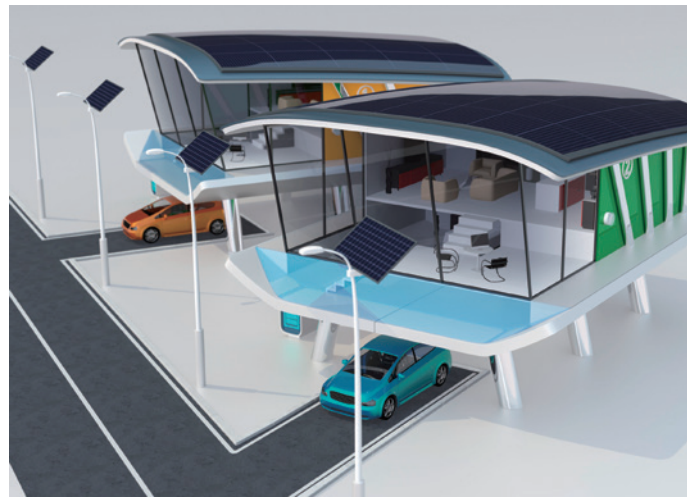

Electric vehicle development

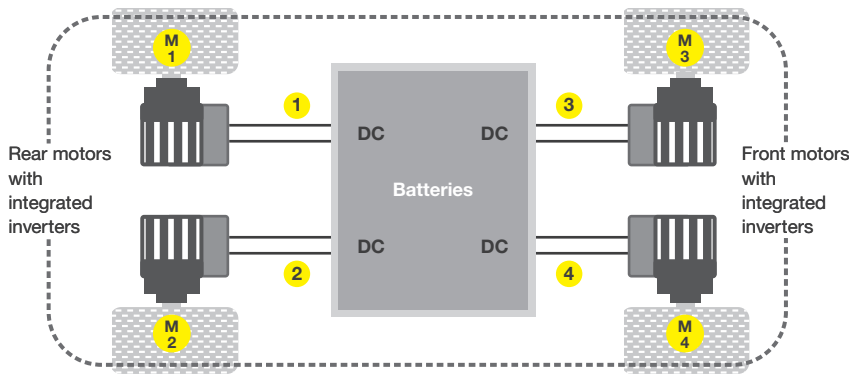

Case 1: Modern drive systems with integrated inverters do not allow access to the AC signals. One of the main measurement tasks is to measure the overall drive train efficiency from DC to mechanical power. The example shows four DC measurements (1 to 4) with the corresponding four mechanical power measurements (M1 to M4).

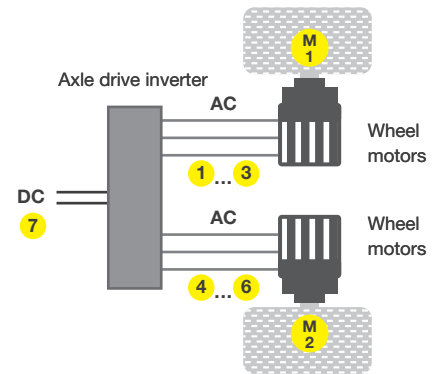

Case 2: Example of an axle power efficiency measurement from DC (7) to dual three-phase AC (1 to 3 and 4 to 6) plus dual mechanical power (M1 and M2).

Overview

Between 16% and 18% of the total charge of an electric car is consumed by electric drive system losses. Electric and hybrid car manufacturers therefore need to accurately evaluate motor and inverter control in order to achieve higher precision and greater efficiency. Additionally, the accurate analysis of inverter waveforms without interference from switching noise is a key part of evaluating the motor drive circuit.

Key requirements

- Multi-phase measurements from battery, inverter, and motor
- Evaluation of motor characteristics such as torque, rotation speed and direction, slip, and electrical angle
- Battery charging/discharging characteristics
- Harmonic analysis of inverter signals at various rotation speeds

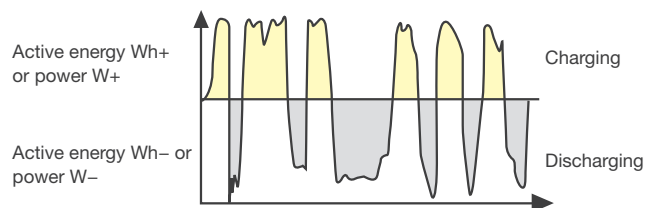

Battery charging and discharging characteristics

The WT5000 advantage

With high-accuracy, multi-channel power measurements, evaluation of up to four motors and harmonic comparison capabilities, the WT5000 helps automotive engineers improve conversion efficiency, reduce charging times, and improve driving range.

Guaranteed accuracy in multi-channel measurements

The WT5000 enables simultaneous measurements of voltage, current, power, torque, rotation speed, electrical angle, and mechanical power.

Motor evaluation and mechatronic efficiency

Measure rotation speed, torque, and output (mechanical power) of motors from analog/pulse inputs of rotation or torque sensors. A single WT5000 can be configured for synchronized measurements from up to four motors simultaneously.

Battery charging and discharging characteristics

Integration of instantaneous positive and negative values of energy allows the evaluation of battery charging and discharging characteristics.

Harmonics analysis and comparisons

With the ability to measure harmonics up to the 500th order even at low rotation speeds, the WT5000 supports harmonic analysis without the need for an external sampling clock.

Renewable energy development

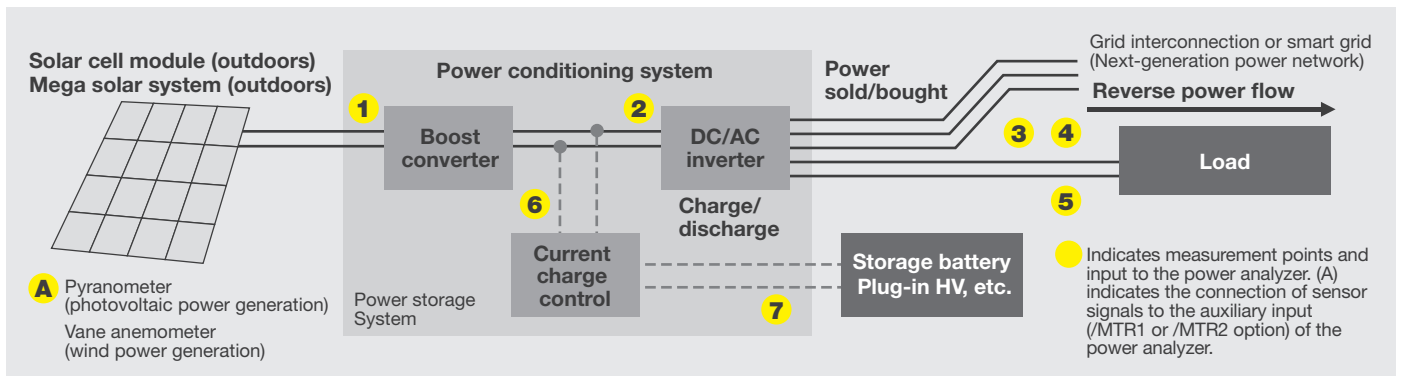

Overview

Energy generated by photovoltaic cell modules and wind turbines is converted from DC to AC by a power conditioner. Minimizing losses in these conversions is key to improving the efficiency of the overall energy system.

Key requirements

- Multi-phase measurements from boost converter, inverter, and storage battery
- Evaluation of maximum power and instantaneous peak values
- Energy bought and sold in grid
- Battery charging/discharging characteristics
- Harmonic analysis of inverter signals at various generator speeds

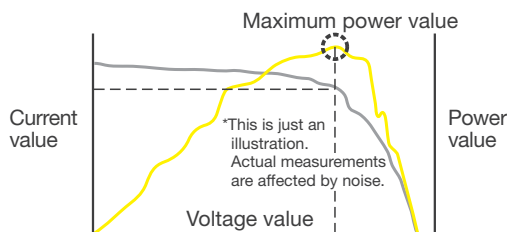

Typical voltage, current, and power measurements in MPPT control

The WT5000 advantage

The WT5000 helps engineers working in the development of renewable energy solutions, to improve conversion efficiency by offering precision insights in charging, discharging, storage, and overall efficiency.

Multi-channel power measurements

Evaluate power conditioner efficiency with simultaneous measurements from the inputs and outputs of the boost converter, inverter, and storage battery. With measurement capabilities from up to seven input elements, the WT5000 is ideal for voltage, current, power, and frequency (for AC) before and after each converter, as well as converter efficiency and charging efficiency.

Instantaneous peak power

In photovoltaic power generation, a Maximum Power Point Tracker (MPPT) controller varies the voltage to maximize energy harvested from the solar panel. The WT5000 is capable of measuring not only the voltage, current, and power but also the voltage, current, and power peak value plus (+) and minus (-) sides, respectively

Energy bought/sold and charged/discharged

The WT5000 provides a current integration (q), apparent power integration (WS), reactive power integration (WQ), and effective power integration capable of integration in the power sold/bought and charge/discharge modes.

Harmonics analysis and comparisons

Voltage fluctuations and harmonics flow into the power systems due to reverse power flow. The harmonic measurement function enables measurement of harmonic components to compute and display total harmonic distortion (THD) and harmonic distortion factor.

Inverter/motor drives

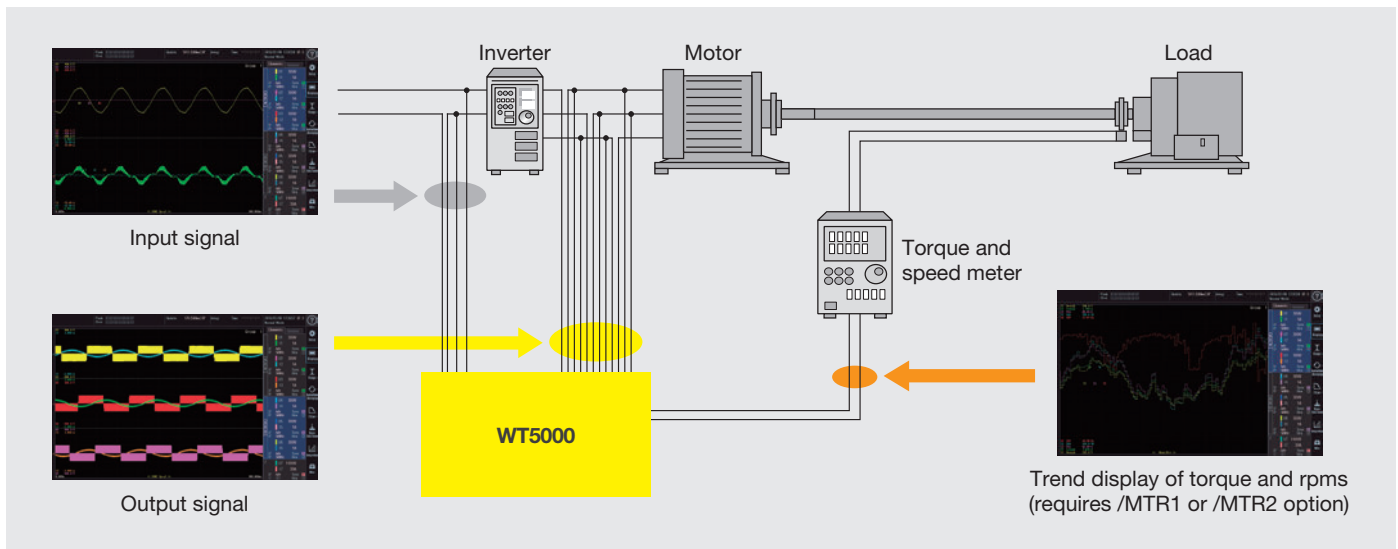

Overview

Motor drive technology has become more complex in recent years, pure sine-wave PWM is less common, and cases where the mean voltage differs greatly from the fundamental voltage waveform are more frequent.

Key requirements

- Multi-phase measurements from battery, inverter, and motor
- Evaluation of motor characteristics such as torque, rotation speed and direction, slip, and electrical angle
- Harmonic analysis of inverter signals at various rotational speeds

The WT5000 advantage

With high-accuracy, multi-channel power measurements, motor evaluation and harmonic comparison capabilities, the WT5000 helps engineers in motor and drive development improve power consumption and conversion efficiency in inverter/motor drive systems.

Guaranteed accuracy across a wide range

The WT5000 guarantees a basic power accuracy of $\pm 0.03\%$, between 1% and 130% of the selected voltage and current measurement ranges, at 50/60 Hz.

It supports simultaneous measurements from the inputs and outputs of the boost converter, inverter, and storage battery.

Inverter and motor efficiency

In addition to computing power conversion efficiency of the inverter and motor (up to seven power inputs), the WT5000 also allows the measurement of rotational speed, torque, and output (mechanical power) from the analog/pulse inputs of the rotation or torque sensor.

Harmonics analysis and comparisons

With the ability to measure harmonics up to the 500th order even at low rotation speeds, the WT5000 supports harmonic analysis without the need of an external sampling clock.

Magnetic characteristics testing

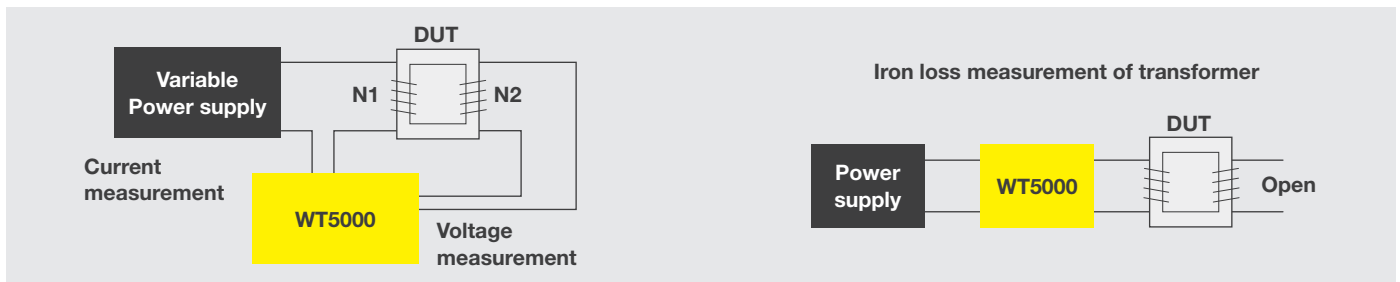

Overview

In transformer or reactor development, the WT5000 can be used to evaluate magnetic material characteristics using the Epstein frame system.

Key requirements

- High-precision measurements of primary coil current and secondary coil voltage are needed
- High accuracy in low-power factor is needed
- The magnetic flux density B and AC magnetic field H are key parameters to calculate iron loss

The WT5000 advantage

Highest voltage and current accuracy

WT5000 provides the highest power accuracy:
0.01% of reading + 0.02% of range (50/60 Hz)

High accuracy at low-power factor

Effect of power factor on the WT5000:
0.02% of S (0.5 A or more)
0.07% of S (200 mA or less)

Power calibration

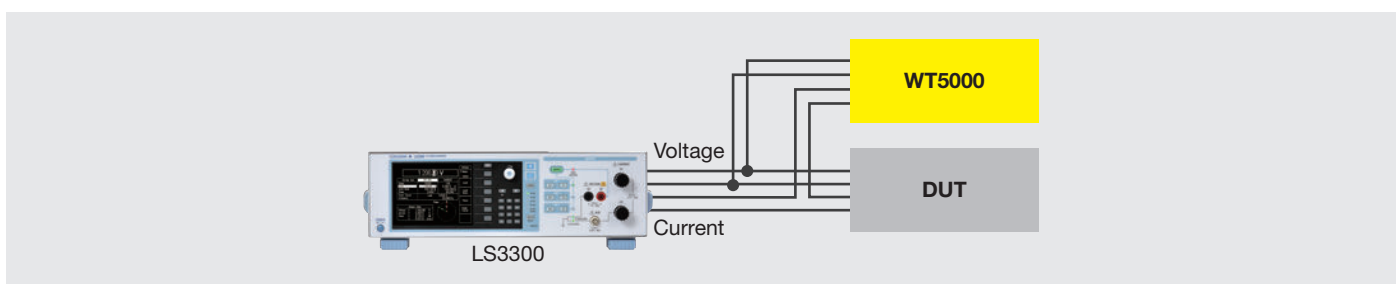

Overview

For those who use a large number of power meters, the WT5000 can be used as a reference standard for periodic in-house calibration of power measurement instruments, such as the WT300E series and WT500.

Key requirements

- Sufficient power accuracy is needed for power measurement instruments
- Power factor is adjustable, and the accuracy in low-power factor is guaranteed

The WT5000 advantage

Highest power accuracy

WT5000 provides the highest power accuracy:
0.01% of reading + 0.02% of range (50/60 Hz)

High accuracy at low power factor

Effect of power factor of the WT5000:
0.02% of S (0.5 A or more)
0.07% of S (200 mA or less)

Harmonic and voltage fluctuation/flicker measurement

Harmonics regulation test*1*2

Combined with the /G7 option of the WT5000 and the integrated software platform IS8011/IS8012, the WT5000-measured harmonic data can be saved into a PC to judge the level according to IEC regulations. To support large equipment over 16 A/phase (IEC61000-3-12), the special CT200 current sensor model can be used.

Voltage fluctuation and flicker regulation test*1*2

The WT5000 with the /G7 option can measure voltage fluctuation and can conduct a flicker test, according to IEC61000-3-3 regulations. This option shows a trend of parameters such as dc, dmax and Pinst (instantaneous flicker sensation). To capture test results, this option generates a comprehensive test report.

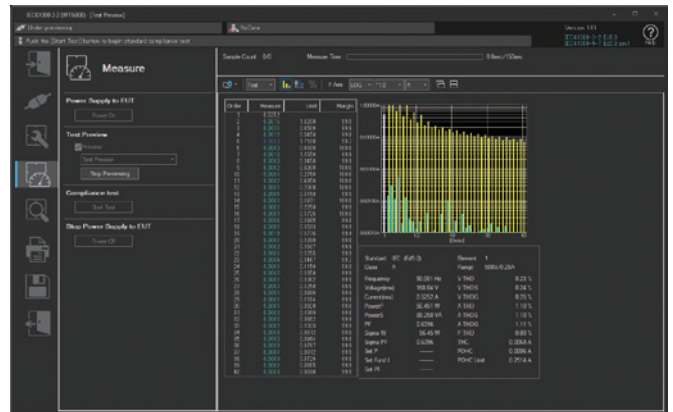

Example of harmonics and the bar graph

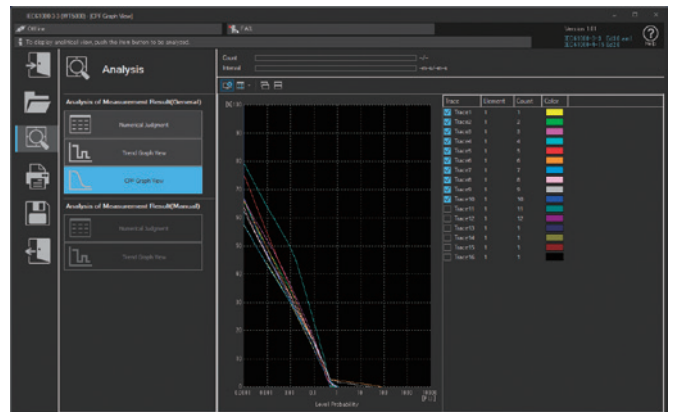

Example of CPF flicker graph

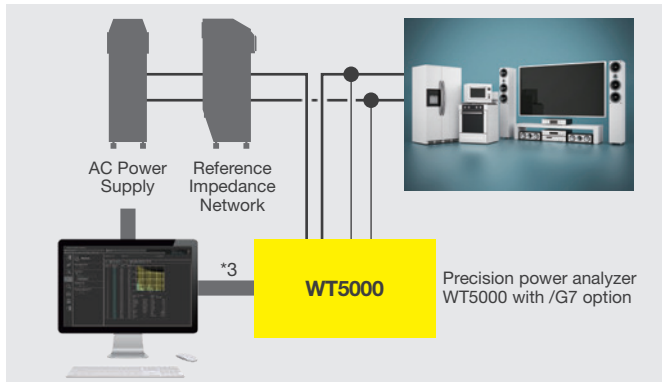

*1: Supported standards:
 • Harmonics
 EN61000-3-2, IEC61000-3-2, EN61000-3-12, IEC61000-3-12, JIS C 61000-3-2
 • Voltage fluctuation/flicker
 EN61000-3-3, IEC61000-3-3, EN61000-3-11, IEC61000-3-11
 *2: 30 A/ 5 A High Accuracy Element (760901/760902) are available.
 *3: GP-IB, Ethernet, and USB communications are available.

Software

Integrated measurement software platform IS8000

The IS8000 software platform is an integrated solution that accelerates engineering workflow. It is a revolutionary software solution that tightly integrates the timing, control, and data collection from multiple instruments, creating a comprehensive measurement suite that delivers high confidence, efficiency, and unity.

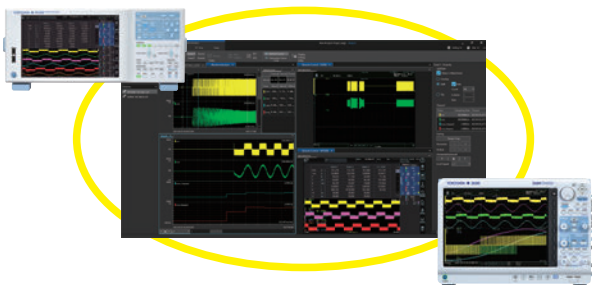

See BU IS8000-01EN for more detail about IS8000

High-precision synchronized measurement of power values and waveform data

The DL950 ScopeCorder and WT5000 support the IEEE1588 standard.

This allows power measured values and transient physical quantities to be synchronized with an error of less than 500 μ s and displayed on the IS8000. It is effective for efficiency evaluation and ECU design, which are essential for designing more efficient motor inverters.

Application software for WT series WTVIEWER E

WTVIEWER E software enables PC connectivity for Yokogawa power analyzers such as the WT5000, WT3000E, WT1800E, WT500, and WT300E through Ethernet, USB, GPIB, or RS232. With multi-channel measurements, multi-unit connectivity, and multilingual support, the WTVIEWER E allows users to easily control, monitor, collect, analyze, and save remote measurements from up to any four power analyzers simultaneously.

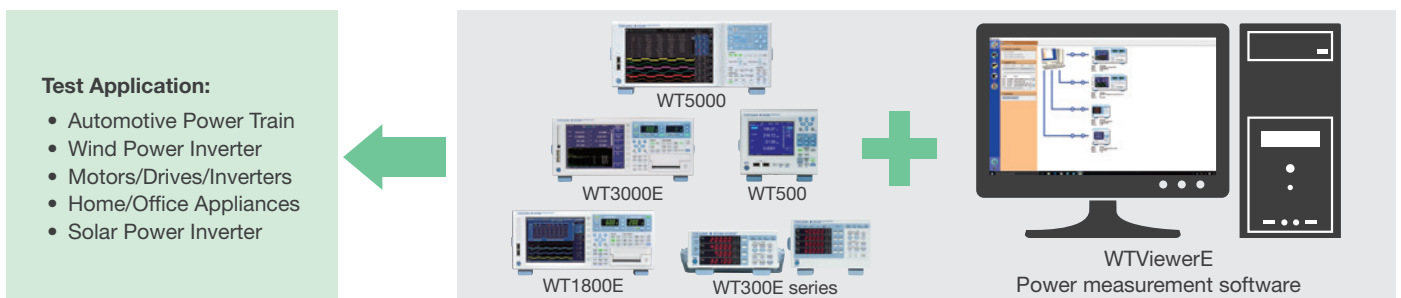

Real-time control

WTVIEWER E allows users to analyze and control remote measurements in real time or use previously acquired data. In the online mode, users have real-time control of measurements from each connected instrument, allowing them to remotely start or stop integration or collect live measurement values. Users can analyze the latest acquired or previously stored data in the offline mode as well.

Multi-channel measurements

With the WTVIEWER E, users can simultaneously view up to 12 waveforms, eight trends, eight vectors, and six harmonic bar graphs in split screen mode or zoom in using cursors for more detail on a particular area of interest. Users can customize, save, and load screen layouts as well as specify the data to be saved in CSV format. The software also allows users to create custom computations combining values from multiple power analyzers.

*Data update rate is required to set 50 msec or slower when using the WTVIEWER E.

Specifications for 760901 (30 A high accuracy element), 760902 (5 A high accuracy element), and 760903 (current sensor element)

Element style and the installation	
Element	Plug-in unit type
Number of slots	7
Installed style	Modular style dedicated to WT5000 (main body)
Mixed installation	Possible for both 30 A and 5 A element together
Installation with empty slot	Possible, however, user cannot make use of elements after empty slot.
Live installation or pulling out	Impossible

Input (760901/760902)

Input terminal type	
Voltage	Plug-in terminal (safety terminal)
Current	Direct input: Plug-in terminal (safety terminal) External Current Sensor input: Isolated BNC

Input format	
Voltage	Floating input, resistive voltage divider
Current	Floating input, through shunt

Measurement range	
Voltage	1.5/3/6/10/15/30/60/100/150/300/600/1000 V (Crest factor CF3) 0.75/1.5/3/5/7.5/15/30/50/75/150/300/500 V (Crest factor CF6/CF6A)

Current	
Direct input	760901 500 mA, 1 A, 2 A, 5 A, 10 A, 20 A, 30 A (Crest factor CF3) 250 mA, 500 mA, 1 A, 2.5 A, 5 A, 10 A, 15 A (Crest factor CF6/CF6A)
	760902 5 mA, 10 mA, 20 mA, 50 mA, 100 mA, 200 mA, 500 mA, 1 A, 2 A, 5 A (Crest factor CF3) 2.5 mA, 5 mA, 10 mA, 25 mA, 50 mA, 100 mA, 200 m, 500 mA, 2.5 A (Crest factor CF6/CF6A)
External Current Sensor input	50 mV, 100 mV, 200 mV, 500 mV, 1 V, 2 V, 5 V, 10 V (Crest factor CF3) 25 mV, 50 mV, 100 mV, 250 mV, 500 mV, 1 V, 2.5 V, 5 V (Crest factor CF6/CF6A)

Instrument loss	
Voltage	Input resistance 10 MΩ ±1% (Approx. 12 pF)
Current	Direct input 760901 Input resistance: 6.5 Ω ±10% + Approx. 0.3 μH 760902 Input resistance: 0.5 Ω ±10% + Approx. 0.3 μH input inductance: 0.11 Ω ±10% + Approx. 0.3 μH
	External Current Sensor input Input resistance 1 MΩ ±1% (Approx. 50 pF)

Instantaneous maximum allowable input (1 s or less)	
Voltage	Peak voltage of 2.5 kV or RMS of 1.5 kV whichever is lower
Current	Direct input 760901 Peak current of 150 A or RMS of 50 A whichever is lower 760902 Peak current of 30 A or RMS of 15 A whichever is lower
	External Current Sensor input Peak voltage is less than 10 times of the range or 25 V whichever is lower

Continuous maximum allowable input	
Voltage	Peak voltage of 1.6 kV or RMS of 1.5 kV whichever is lower If the frequency of the input voltage exceeds 100 kHz, (1200 – f) Vrms or less, the "f" indicates the frequency of the input voltage and the unit is kHz
Current	Direct input 760901 Peak current of 90 A or RMS of 33 A whichever is lower 760902 Peak current of 10 A or RMS of 7 A whichever is lower
	External Current Sensor input Peak voltage is less than 5 times the range or 25 V whichever is lower

Voltage Continuous maximum voltage to earth (DC to 50/60 Hz)	
Voltage input terminals	(DC to 50/60 Hz) 1000 V CAT II
Current input terminals	(DC to 50/60 Hz) 1000 V CAT II
External Current Sensor input connector	(DC to 50/60 Hz) 1000 V CAT II

Influence from common mode voltage	
Apply 1000 Vrms for input terminal and case with the voltage input terminals shorted, the current input terminals open, and the external current sensor input terminals shorted.	
50/60 Hz: ±0.01% of range or less Reference value: Up to 200 kHz: Voltage ±((Maximum rated range)/(rated range) × 0.001 × f% of range) or less	
Current	Direct input ±((Maximum rated range)/(rated range) × 0.001 × f% of range) or less
	External Current Sensor input ±((Maximum rated range)/(rated range) × 0.001 × f% of range) or less However, 0.01% or more, unit of f is kHz
The maximum rated range which is equation is Voltage 1000 V, Current direct input 30 A for 760901 5 A for 760902, External Current Sensor input 10 V.	

A/D converter	
Simultaneous voltage and current input conversion	
Resolution: 18 bit	
Conversion speed (Sampling period): Maximum 100 ns	

Lower frequency limit of measurement	
Sync source period average method	

Data update rate	10 ms	50 ms	100 ms	200 ms	500 ms
Measurement lower limit frequency	200 Hz	45 Hz	20 Hz	10 Hz	5 Hz
Data update rate	1 s	2 s	5 s	10 s	20 s
Measurement lower limit frequency	2 Hz	1 Hz	0.5 Hz	0.2 Hz	0.1 Hz

Digital filtering average method
FAST: 100 Hz
MID: 10 Hz
SLOW: 1 Hz
VSLW: 0.1 Hz

Input (760903)

Output terminal type	
Sensor power:	D-sub 9-pin socket
Probe power:	Dedicated connector

Output voltage	
Sensor power:	±15 V
Probe power:	±12 V, but output is off when Terminal is set to Sensor

Output current	
Sensor power:	1.8 A
Probe power:	0.8 A, but output is off when Terminal is set to Sensor
Total output when multiple elements are used	<ul style="list-style-type: none"> • Sensor power: 8 A • Probe power supply: The total absolute value of the positive and negative currents of the power supply is included in the positive sensor power supply current.

Input terminal type	
Voltage	Same as 760901
Current	<ul style="list-style-type: none"> • Sensor input: D-sub 9-pin socket (non-isolated) • Probe input: BNC connector (non-isolated)

Input type	
Voltage	Same as 760901
Current	<ul style="list-style-type: none"> • Sensor input: Input through shunt • Probe input: Input through resistive voltage divider

Measurement range	
Voltage	Same as 760901
Current	<ul style="list-style-type: none"> • Sensor input • Input resistance: 1 Ω 10 mA, 25 mA, 50 mA, 100 mA, 250 mA, 500 mA, 1 A (crest factor CF3) 5 mA, 12.5 mA, 25 mA, 50 mA, 125 mA, 250 mA, 500 mA (crest factor CF6/CF6A) • Input resistance: 1.5 Ω 6.67 mA, 16.7 mA, 33.3 mA, 66.7 mA, 167 mA, 333 mA, 667 mA (crest factor CF3) 3.33 mA, 8.33 mA, 16.7 mA, 33.3 mA, 83.3 mA, 167 mA, 333 mA (crest factor CF6/CF6A) • Input resistance: 5 Ω 5 mA, 10 mA, 20 mA, 50 mA, 100 mA, 200mA (crest factor CF3) 2.5 mA, 5 mA, 10 mA, 25 mA, 50 mA, 100mA (crest factor CF6/CF6A) • Input resistance: 10 Ω 5 mA, 10 mA, 25 mA, 50 mA, 100 mA (crest factor CF3) 2.5 mA, 5 mA, 12.5 mA, 25 mA, 50 mA (crest factor CF6/CF6A)
Probe input	50 mV, 100 mV, 200 mV, 500 mV, 1 V, 2 V, 5 V, 10 V (crest factor CF3) 25 mV, 50 mV, 100 mV, 250 mV, 500 mV, 1 V, 2.5 V, 5 V (crest factor CF6/CF6A)

Instrument loss	
Voltage	Same as 760901

Input impedance	
Current	<ul style="list-style-type: none"> • Sensor input: Input resistance: 1 Ω Approx. 1 Ω + approx. 0.2 μH Input resistance: 1.5 Ω Approx. 1.5 Ω + approx. 0.2 μH Input resistance: 5 Ω Approx. 5 Ω + approx. 0.2 μH Input resistance: 10 Ω Approx. 10 Ω + approx. 0.2 μH Probe input: Input resistance: 1MΩ ± 1%, input capacitance: approx. 50 pF

Instantaneous maximum allowable input	
Voltage	Same as 760901 (within 1 s)
Current	<ul style="list-style-type: none"> • Sensor input: Input resistance: 1 Ω Peak value of 1.8 A or rms value of 1.2 A, whichever is less. Input resistance: 1.5 Ω Peak value of 1.2 A or rms value of 0.84 A, whichever is less. Input resistance: 5 Ω Peak value of 0.36 A or rms value of 0.25 A, whichever is less. Input resistance: 10 Ω Peak value of 0.18 A or rms value of 0.12 A, whichever is less. (with in 0.1 s) Probe input: Peak value at 10 times the range or 25 V, whichever is less (with in 0.1 s)

Continuous maximum allowable input	
Voltage	Same as 760901 (within 1 s)
Current	<ul style="list-style-type: none"> • Sensor input: Input resistance: 1 Ω Peak value of 1.5 A or rms value of 1.1 A, whichever is less. Input resistance: 1.5 Ω Peak value of 1.0 A or rms value of 0.73 A, whichever is less.

Input resistance: 5 Ω
 Peak value of 0.3 A or rms value of 0.22 A, whichever is less.
 Input resistance: 10 Ω
 Peak value of 0.15 A or rms value of 0.11 A, whichever is less.
 Probe input:
 Peak value at 5 times the range or rms value of 25 V, whichever is less

Maximum rated voltage to earth (DC to 50/60 Hz)	Voltage input terminal 1000 V CAT II
Influence of voltage to earth	1000 Vrms is applied between an input terminal and WT5000 with the voltage input terminals shorted. 50/60 Hz: ±0.01% of range or less. Reference values up to 200 kHz: Voltage: ±{(maximum rated range)/(rated range) × 0.001 × f% of range} or less However, 0.01% or greater. The maximum range rating in the equation is 1000 V. The unit of f in the equations is kHz.
A/D converter	Same as 760901
Measurement frequency bandwidth	Same as 760901
Lower limit of measurement frequency	Same as 760901

Accuracy (six-month)	
One-year Accuracy	Multiply the reading accuracy of the six-month accuracy by a factor of 1.5.
Conditions	Temperature: 23±5°C. Humidity: 30 to 75% RH. Input waveform: Sine wave. λ (Power factor): 1. Common mode voltage: 0 V. Crest factor: CF3 Line filter: OFF Frequency filter: On (1 kHz or less when average method is Sync source period average) Signal level of Synch source: Same as frequency measurement After warm-up time (30 minutes) After Zero calibration of measurement range change under wiring with calibrators Unit of f of below formulas is kHz Input range AC: 1 to 110% of range DC: 0 to 110% of range

	760901/760902	760903	
Voltage	DC	±(0.02% of rdg + 0.05% of rng)	
	0.1 Hz ≤ f < 10 Hz	±(0.03% of rdg + 0.05% of rng)	
	10 Hz ≤ f < 45 Hz	±(0.03% of rdg + 0.05% of rng)	±(0.03% of rdg + 0.03% of rng)
	45 Hz ≤ f ≤ 66 Hz	±(0.01% of rdg + 0.02% of rng)	
	66 Hz < f ≤ 1 kHz	±(0.03% of rdg + 0.04% of rng)	±(0.03% of rdg + 0.03% of rng)
	1 kHz < f ≤ 10 kHz	±(0.1% of rdg + 0.05% of rng) Add 0.015% × f of rdg (lower than 10 V rng.)	
	10 kHz < f ≤ 50 kHz	±(0.3% of rdg + 0.1% of rng)	
	50 kHz < f ≤ 100 kHz	±(0.6% of rdg + 0.2% of rng)	
	100 kHz < f ≤ 500 kHz	±{(0.006 × f)% of rdg + 0.5% of rng}	
	500 kHz < f ≤ 1 MHz	±{(0.022 × f - 8)% of rdg + 1% of rng}	
Current	DC	±(0.02% of rdg + 0.05% of rng)	
	0.1 Hz ≤ f < 10 Hz	±(0.03% of rdg + 0.05% of rng)	
	10 Hz ≤ f < 45 Hz	±(0.03% of rdg + 0.05% of rng)	±(0.03% of rdg + 0.03% of rng)
	45 Hz ≤ f ≤ 66 Hz	±(0.01% of rdg + 0.02% of rng) ±0.5 μA*	
	66 Hz < f ≤ 1 kHz	±(0.03% of rdg + 0.04% of rng)	±(0.03% of rdg + 0.03% of rng)
	1 kHz < f ≤ 10 kHz	±(0.1% of rdg + 0.05% of rng)	
	10 kHz < f ≤ 50 kHz	±(0.3% of rdg + 0.1% of rng)	
	50 kHz < f ≤ 100 kHz	±(0.6% of rdg + 0.2% of rng)	
	100 kHz < f ≤ 200 kHz	±{(0.00725 × f - 0.125)% of rdg + 0.5% of rng}	
	200 kHz < f ≤ 500 kHz	±{(0.00725 × f - 0.125)% of rdg + 0.5% of rng}	
Active power (power factor 1)	DC	±(0.02% of rdg + 0.05% of rng)	
	0.1 Hz ≤ f < 10 Hz	±(0.08% of rdg + 0.1% of rng)	
	10 Hz ≤ f < 30 Hz	±(0.08% of rdg + 0.1% of rng)	±(0.04% of rdg + 0.04% of rng)
	30 Hz ≤ f < 45 Hz	±(0.05% of rdg + 0.05% of rng)	±(0.04% of rdg + 0.04% of rng)
	45 Hz ≤ f ≤ 66 Hz	±(0.01% of rdg + 0.02% of range)	
	66 Hz < f ≤ 1 kHz	±(0.05% of rdg + 0.05% of rng)	±(0.04% of rdg + 0.04% of rng)
	1 kHz < f ≤ 10 kHz	±(0.15% of rdg + 0.1% of rng) Add 0.01% × f of rdg (lower than 10 V rng)	
	10 kHz < f ≤ 50 kHz	±(0.3% of rdg + 0.2% of rng)	
	50 kHz < f ≤ 100 kHz	±(0.7% of rdg + 0.3% of rng)	
	100 kHz < f ≤ 200 kHz	±{(0.008 × f)% of rdg + 1% of rng}	
Bandwidth	Direct input ¹ : DC to 5 MHz (Typical, -3 dB) External Current Sensor input ¹ : DC to 5 MHz (Typical, -3 dB) Sensor input ² : DC to 5 MHz (Typical, -3 dB) Probe input ² : DC to 5 MHz (Typical, -3 dB) ¹ 760901/760902 ² 760903		

*rdg: reading, rng: range

¹Accuracy when used in conjunction with AC/DC current sensor or current clamp probe: Add the accuracy of the power analyzer and that of the AC/DC current sensor or current clamp probe.

- Range of guaranteed accuracy by frequency, voltage, and current
All accuracies between 0.1 Hz and 10 Hz are reference values.
If the voltage exceeds 750 V at 30 kHz to 100 kHz, the voltage and power values are reference values.
If the current exceeds 20 A at DC, 10 Hz to 45 Hz, or 400 Hz to 100 kHz, the current and power accuracies are reference values.
- Influence of data update rate
Add the following value to the accuracy with Sync source period method
10 ms, 50 ms: ±0.03% of reading
100 ms: ±0.02% of reading
- Accuracy for crest factor CF6/CF6A
Same as the range accuracy of crest factor CF3 for twice the range.
- Influence of Power Factor λ
When λ = 0
±Apparent power reading × 0.02% of the range, 45 Hz to 66 Hz
For frequencies other than the above (Reference values):
±Apparent power reading × (0.02 + 0.05 × f%)
When 0 < λ < 1
±Power reading × [(power reading error %) + (power range error %) × (power range/apparent power reading) + (tan φ × (influence % when λ = 0))]
However, φ is the phase angle between the voltage and current.

Temperature coefficient (760901/760902)
±0.01% of reading/°C at 5 to 18°C or 28 to 40°C

Temperature coefficient (760903)
At 5°C to 18°C or 28°C to 40°C, add the following value to the voltage measurement accuracy.
±0.01% of reading/°C
At 5°C to 18°C or 28°C to 40°C, add the following value to the current and power measurement accuracy.
When the input resistance is 10 Ω or 5 Ω
±0.01% of reading/°C
±0.3 μA/°C (for DC measurement values)
When the input resistance is 1.5 Ω or 1 Ω
±0.01% of reading/°C
±3 μA/°C (for DC measurement values)

Effective input range
Udc and ldc: 0% to ±130% of the measurement range (excluding the 1000 V range)*
Udc 1000 V range: 0% to ±150%*
Urms and lrms: 1% to 130% of the measurement range*
Umn and lmn: 10% to 130% of the measurement range*
Urmn and lrmn: 10% to 130% of the measurement range*
Power
DC measurement: 0% to ±150% when the voltage measurement range is 1000 V; 0% to ±130% otherwise*
AC measurement: 1% to 130%* of the voltage and current ranges; up to ±130%* of the power range

*The accuracy for 110% to 130% of the measurement range (excluding the 1000 V range) is range error × 1.5. If the input voltage exceeds 600 V, add 0.02% of reading. However, the signal level for the signal sync period average must meet the input signal level for frequency measurement. When the crest factor is set to CF6 or CF6A, double the lower limit.

Influence of Line filter (760901/760902)
Bessel 5 orders LPF, fc = 1 MHz
Voltage/Current Up to 100 kHz: Add ±(20 × f/fc) % of reading
Power Up to 100 kHz: Add ±(40 × f/fc) % of reading
Refer to WT5000 (main body) line filter, if lower than 100 kHz of fc

Influence of Line filter (760903)
Bessel, 5th order LPF, cutoff frequency fc: 1 MHz

- When the advanced line filter setting is off
When the line filter is on, add the following to the voltage, current, and active power accuracies.
Voltage, current
f ≤ (fc/10): ±(20 × f/fc) % of reading
Active power
f ≤ (fc/10): ±(40 × f/fc) % of reading
For the filter specifications for fc less than or equal to 100 kHz, see "Line filter" in section 6.7.
- When the advanced line filter setting is on
When the anti-aliasing filter function (AAF) is on, add the following to the voltage, current, active power accuracies.
Voltage, current
f ≤ (fc/10): ±(20 × f/fc) % of reading
Active power
f ≤ (fc/10): ±(40 × f/fc) % of reading
For the filter specifications for fc less than or equal to 100 kHz, see "Line filter" in section 6.7.

When the high frequency rejection function (HFR) is on, add the following to the voltage, current, active power accuracies.
However, if the AAF is set to ON simultaneously, the accuracy addition of the AAF takes precedence.

Current
50 kHz ≤ f ≤ 100 kHz: ±(0.006 × f - 0.1) % of reading
100 kHz < f ≤ 300 kHz: ±(0.035 × f - 2.0) % of reading
300 kHz < f ≤ 500 kHz: ±(0.040 × f + 2.0) % of reading
Active power (power factor 1)
10 kHz ≤ f ≤ 50 kHz: ±(0.005 × f - 0.05) % of reading
50 kHz ≤ f ≤ 100 kHz: ±(0.013 × f - 0.3) % of reading
100 kHz < f ≤ 500 kHz: ±(0.050 × f - 3.0) % of reading
Influence of power factor (λ)
λ = 0: ±(0.01 × f) % of apparent power reading
However, be aware that these figures are reference values.
The unit of fc and f in the accuracy equations is kHz.

Frequency measurement

Measurement range

Update rate	Measurement range
10 ms	200 Hz ≤ f ≤ 2 MHz
50 ms	45 Hz ≤ f ≤ 2 MHz
100 ms	20 Hz ≤ f ≤ 2 MHz
200 ms	10 Hz ≤ f ≤ 2 MHz
500 ms	5 Hz ≤ f ≤ 2 MHz
1 s	2 Hz ≤ f ≤ 2 MHz
2 s	1 Hz ≤ f ≤ 2 MHz
5 s	0.5 Hz ≤ f ≤ 2 MHz
10 s	0.2 Hz ≤ f ≤ 2 MHz
20 s	0.1 Hz ≤ f ≤ 2 MHz

Measurement range at auto update mode: 0.1 Hz ≤ f ≤ 2 MHz
Accuracy ±(0.06% of reading + 0.1 mHz)

Conditions

Signal level: For crest factor CF3, more than 30% of range
For crest factor CF6/6 A, more than 60% of range
When the frequency is smaller than or equal to 2 times of the above lower frequency, the input level of more than 50% of ranges is necessary.
Frequency filter: 0.1 Hz ≤ f < 100 kHz: 100 Hz
100 Hz ≤ f < 1 kHz: 1 kHz
1 kHz ≤ f < 100 kHz: 100 kHz

Notes (760903)

Limitations when used in combination with the CT1000
Use within the following ambient temperature derating.
CT ambient temperature 45°C or more: Primary current 900 Apk or less
CT ambient temperature 45°C or less: Follows the CT1000 specifications
Restrictions when used in combination with the 10 m sensor cable 761956
CT2000A primary current: 2100 Apk or less

Harmonic Measurement

Measurement target All installed elements

Method PLL synchronization method

Frequency range Fundamental frequency: 0.1 Hz to 300 kHz
Analysis frequency: 0.1 Hz to 1.5 MHz

PLL source Select the voltage or current of input elements, or the external clock.
Input level: See element specifications
The condition under frequency filter ON is the same as frequency measurement.
Condition of frequency filter ON
0.1 Hz < f < 100 kHz: 100 Hz
100 Hz < f < 1 kHz: 1 kHz
1 kHz < f < 10 kHz: 10 kHz
10 kHz < f < 100 kHz: 100 kHz

FFT points Select from 1024 or 8192

Window function Rectangular

Anti-aliasing filter Set with line filter and harmonic filter

FFT points 8192 (10 MS/s)

Fundamental frequency	Sampling rate	Window width	Upper limit of measured order	
			U, I, P, Ø, ØU, ØI	Other measured values
0.5 Hz to 3 kHz	f × 1024	8 waves	500* order	100 order
3 kHz to 7.5 kHz	f × 1024	8 waves	200* order	100 order
7.5 kHz to 15 kHz	f × 512	16 waves	100 order	100 order
15 kHz to 30 kHz	f × 256	32 waves	50 order	50 order
30 kHz to 75 kHz	f × 128	64 waves	20 order	20 order
75 kHz to 150 kHz	f × 64	128 waves	10 order	10 order
150 kHz to 300 kHz	f × 32	256 waves	5 order	5 order

*Upper limit of measured order is 100 or smaller, when Update Rate is set to 50 ms. Further, harmonic analysis is not executed (disabled) when the update interval is 10 ms.

Accuracy

PLL source input level

- 15 V or more of range for voltage input.
- 200 mV or more of range for external current sensor input.
- 50% or more of the measurement range rating for crest factor CF3.
- 100% or more of the measurement range rating for crest factor CF6/CF6A.
- For 500 mA, 1 A, 2 A range, 20 Hz to 1 kHz.

Accuracy

- Add the following accuracy to the normal measurement accuracy.
- When the line filter is OFF

Frequency	Voltage, Current
0.1 Hz ≤ f < 10 Hz	±(0.01% of reading + 0.03% of range)
10 Hz ≤ f < 45 Hz	±(0.01% of reading + 0.03% of range)
45 Hz ≤ f ≤ 66 Hz	±(0.01% of reading + 0.03% of range)
66 Hz < f ≤ 440 Hz	±(0.01% of reading + 0.03% of range)
440 Hz < f ≤ 1 kHz	±(0.01% of reading + 0.03% of range)
1 kHz < f ≤ 10 kHz	±(0.01% of reading + 0.03% of range)
10 kHz < f ≤ 50 kHz	±(0.05% of reading + 0.1% of range)
50 kHz < f ≤ 100 kHz	±(0.1% of reading + 0.2% of range)
100 kHz < f ≤ 500 kHz	±(0.1% of reading + 0.5% of range)
500 kHz < f ≤ 1.5 MHz	±(0.5% of reading + 2% of range)

Frequency	Power
0.1 Hz ≤ f < 10 Hz	±(0.02% of reading + 0.06% of range)
10 Hz ≤ f < 45 Hz	±(0.02% of reading + 0.06% of range)
45 Hz ≤ f ≤ 66 Hz	±(0.02% of reading + 0.06% of range)
66 Hz < f ≤ 440 Hz	±(0.02% of reading + 0.06% of range)
440 Hz < f ≤ 1 kHz	±(0.02% of reading + 0.06% of range)
1 kHz < f ≤ 10 kHz	±(0.02% of reading + 0.06% of range)
10 kHz < f ≤ 50 kHz	±(0.1% of reading + 0.2% of range)
50 kHz < f ≤ 100 kHz	±(0.2% of reading + 0.4% of range)
100 kHz < f ≤ 500 kHz	±(0.2% of reading + 1% of range)
500 kHz < f ≤ 1.5 MHz	±(1% of reading + 4% of range)

Data Streaming (/DS option is required)

IEC Harmonic Measurement (/G7 option and IS8011/IS8012 Harmonic Flicker software is required)

IEC Voltage fluctuation and Flicker (/G7 option and IS8011/IS8012 Harmonic Flicker software is required)

Please see the brochure of specifications (Bulletin WT5000-02 EN).

General specifications (including WT5000 main body)

Warm-up time	About 30 minutes	
Operation environment	Temperature	5 to 40°C
	Humidity	20 to 80% RH (no condensation)
	Operating altitude	2000 m or lower
Storage environment	Installation location	Indoors
	Temperature	-25 to 60°C (no condensation)
Rated power supply voltage	Humidity	20 to 80% RH (no condensation)
	100 to 120 VAC, 220 to 240 VAC	
Allowable power supply voltage fluctuation range	90 to 132 VAC, 198 to 264 VAC	
Rated power supply frequency	50/60 Hz	
Allowable power supply frequency fluctuation range	48 Hz to 63 Hz	
Power consumption	Maximum 560 VA	

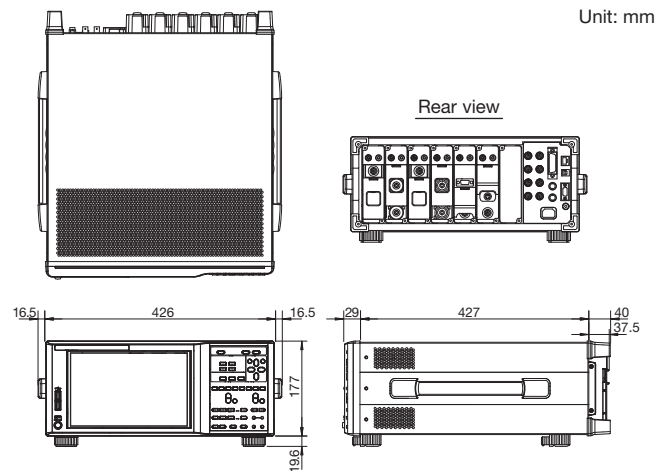



WT5000, 30 A and 5 A High Accuracy Elements (760901 and 760902), and Current Sensor Element (760903) includes LAZER source inside.















Complies with 21 CFR 1040.10 and 1040.11 except for deviations pursuant to Laser Notice No.50, dated June 24, 2007
4-3-8 Myojin-cho, Hachioji-shi, Tokyo 192-8566, Japan

Accessories

Related products

<p>AC/DC Current Sensor</p>  <p>CT60/CT200/CT1000/CT1000A/CT2000A Current Output</p> <p>AC/DC Current Sensors</p> <ul style="list-style-type: none"> DC to 800 kHz/60 Apeak, DC to 500 kHz/200 Apeak, DC to 300 kHz/1000 Apeak, DC to 300 kHz/1000 Arms (1500 Apeak), DC to 40 kHz/2000 Arms (3000 Apeak) Wide dynamic range -2000 A to 0 A to +2000 A (DC)/2000 Arms (AC) Wide measurement frequency range: DC and up to 800 kHz High-precision fundamental accuracy: $\pm(0.05\%$ of reading + 30 μA) ± 15 V DC power supply, connector, and load resistor required. For detailed information, see Current Sensors & Accessories Catalog Bulletin CT1000-00E. 	<p>Clamp-on Probe</p>  <p>751552 Current Output</p> <p>Current Clamp-on Probe</p> <ul style="list-style-type: none"> AC 1000 Arms (1400 Apeak) Measurement frequency range: 30 Hz to 5 kHz Basic accuracy: $\pm 0.3\%$ of reading Maximum allowed input: AC 1000 Arms, maximum 1400 Apeak (AC) Current output type: 1 mA/A <p>A separately sold Safety terminal adapter set (761952), measurement leads (758917), etc. are required for connection to WT5000. For detailed information, see Power Meter Accessory Catalog Bulletin CT1000-00E.</p>	<p>Current Sensor Unit</p>  <p>751522, 751524 Current Output</p> <p>Current Sensor Unit</p> <ul style="list-style-type: none"> DC to 100 kHz/1000 Apeak Wide dynamic range: -1000 A to 0 A to +1000 A (DC)/1000 Apeak (AC) Wide measurement frequency range: DC to 100 kHz (-3 dB) High-precision fundamental accuracy: $\pm(0.05\%$ of reading + 40 μA) Superior noise withstanding ability and CMRR characteristic due to optimized casing design <p>751522/751524 do not conform to CE Marking For detailed information, see Power Meter Accessory Catalog Bulletin CT1000-00E.</p>
--	---	--

Adapters and Cables

 <p>758917</p> <p>Measurement leads</p> <p>Two leads in a set. Use 758917 in combination with 758922 or 758929. Total length: 75 cm. Rating: 1000 V CAT II, 32 A</p>	 <p>758922 Warning</p> <p>Small alligator adapters</p> <p>For connection to measurement leads (758917). Two in a set. Rating: 300 V CAT II</p>	 <p>758929 Warning</p> <p>Large alligator adapters</p> <p>For connection to measurement leads (758917). Two in a set. Rating: 1000 V CAT II</p>	 <p>758923*1</p> <p>Safety terminal adapter set</p> <p>Spring-hold type. Two adapters in a set.</p>	 <p>758931*1</p> <p>Safety terminal adapter set</p> <p>Screw-fastened adapters. Two adapters in a set. 1.5 mm Allen wrench included for tightening.</p>	 <p>758924</p> <p>Conversion adapter</p> <p>For conversion between male BNC and female banana plug</p>
 <p>366924/366925*2 Warning</p> <p>BNC cable</p> <p>BNC-BNC 1 m/2 m. For simultaneous measurements with 2 units or for an external trigger signal.</p>	 <p>701902/701903</p> <p>Safety BNC cable</p> <p>BNC-BNC 1 m/2 m. To connect the Motor evaluation function to a torque sensor.</p>	 <p>761951</p> <p>Safety terminal adapter set</p> <p>Screw-fastened type adapters for 30 A element. Black/Red two adapters in a set.</p>	 <p>761953</p> <p>Safety terminal adapter set</p> <p>Screw-fastened type adapters for 5 A element. Black/Red two adapters in a set.</p>	 <p>761952</p> <p>Safety terminal conversion adapter set</p> <p>Female-female type adapters for 5 A element. Black/Red two adapters in a set. *When using this, terminal shape is the same as the voltage input, please pay attention to miswiring.</p>	 <p>761954/761955/761956</p> <p>Cable for Current Sensor Element</p> <p>Total length: 3 m/5 m/10 m</p>

Warning Due to the nature of this product, it is possible to touch its metal parts. There is a risk of electric shock - use this product with caution.

*1 Maximum diameters of cables that can be connected to the adapters 758923 core diameter: 2.5 mm or less; sheath diameter: 4.8 mm or less 758931 core diameter: 1.8 mm or less; sheath diameter: 3.9 mm or less

*2 Use with a low-voltage circuit (42 V or less)

*3 The coax cable is simply cut on the current sensor side. Preparation by the user is required.

Typical Voltage/Current Connections

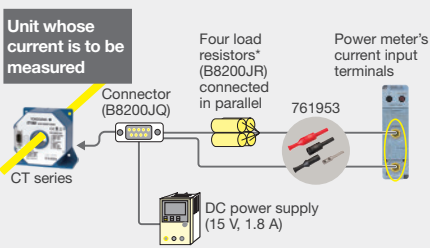
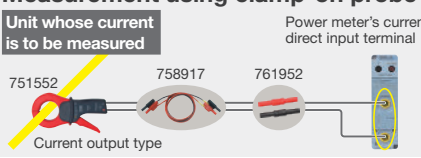
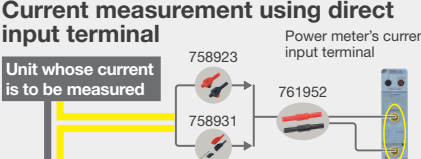
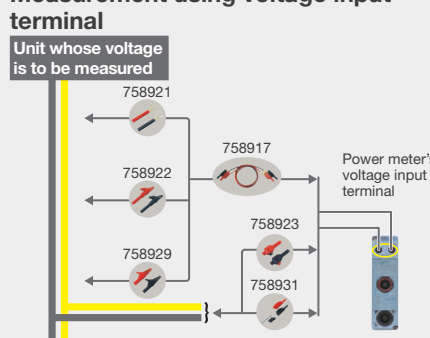
<p>Measurement using current sensor</p> <p>Connection example</p>  <p>Unit whose current is to be measured</p> <p>Four load resistors* (B8200JR) connected in parallel</p> <p>Power meter's current input terminals</p> <p>Connector (B8200JQ)</p> <p>CT series</p> <p>DC power supply (15 V, 1.8 A)</p> <p>761953</p>	<p>Measurement using clamp-on probe</p>  <p>Unit whose current is to be measured</p> <p>Power meter's current direct input terminal</p> <p>751552</p> <p>758917</p> <p>761952</p> <p>Current output type</p> <p>Current measurement using direct input terminal</p>  <p>Unit whose current is to be measured</p> <p>Power meter's current input terminal</p> <p>758923</p> <p>758931</p> <p>761952</p>	<p>Measurement using voltage input terminal</p>  <p>Unit whose voltage is to be measured</p> <p>Power meter's voltage input terminal</p> <p>758921</p> <p>758917</p> <p>758922</p> <p>758923</p> <p>758929</p> <p>758931</p>
--	--	--

*A burden resistor is required for the CT1000, CT200, and CT60.

Model and suffix code

Model	Suffix Code	Descriptions
WT5000		Precision Power Analyzer
Language Menu	-HC	Chinese/English Menu
	-HE	English Menu
	-HG	German/English Menu
	-HJ	Japanese/English Menu
Power Cord	-B	Indian Standard
	-D	UL/CSA Standard, PSE Compliant
	-F	VDE/Korean Standard
	-H	Chinese Standard
	-N	Brazilian Standard
	-Q	BS Standard
	-R	Australian Standard
	-T	Taiwanese Standard
	-U	IEC Plug Type B
Option	/M1	32 GB Built-in Memory
	/MTR1	Motor Evaluation 1
	/DA20*	20 CH D/A Output
	/MTR2*	Motor Evaluation 2
	/DS	Data Streaming
	/G7	IEC Harmonic/Flicker Measurement

*Select only one of these options. /MTR2 option requires installation of /MTR1 option.

Model	Suffix Code	Descriptions
760901		30 A High Accuracy Element
760902		5 A High Accuracy Element
760903		Current Sensor Element

Standard accessories

WT5000

Power cord, rubber feet, cover panel B8216JA 7 sets, user's manual, expanded user's manual, communication interface user's manual, connector (provided only with/DA20)

760901/760902

Safety terminal adapter B9317WB/B9317WC (provided two adapters in a set times input element number)^{*1}, safety terminal adapter A1650JZ/A1651JZ (provided black/red two adapters in a set, times of 30 A input element number)^{*2}, safety terminal adapter B8213YA/B8213YB (provided black/red two adapters in a set, times of 5 A input element number)^{*3}

760903**

Safety terminal adapter B9317WB/B9317WC (provided black/red two adapters in a set times input element number)^{*1}

User's manuals: Start guide (booklet), function/operation, communication manuals (electric file)

- *1: When additional standard accessories are needed, order accessory products, 758931.
 *2: When additional standard accessories are needed, order accessory products, 761951.
 *3: When additional standard accessories are needed, order accessory products, 761953.
 *4: Cable for current sensor is sold separately.

Yokogawa's Approach to Preserving the Global Environment

- Yokogawa's electrical products are developed and produced in facilities that have received ISO14001 approval.
- In order to protect the global environment, Yokogawa's electrical products are designed in accordance with Yokogawa's Environmentally Friendly Product Design Guidelines and Product Design Assessment Criteria.

This is a Class A instrument based on Emission standards EN61326-1 and EN55011 and is designed for an industrial environment.





Operation of this equipment in a residential area may cause radio interference, in which case users will be responsible for any interference which they cause.

■ Any company's names and product names mentioned in this document are trade names, trademarks or registered trademarks of their respective companies.

NOTICE

- Before operating the product, read the user's manual thoroughly for proper and safe operation.

Accessories (sold separately)

Model	Product name	Descriptions
366924	 *1 BNC-BNC Cable	1 m
366925	 *1 BNC-BNC Cable	2 m
701901	1:1 Safety BNC Adapter Lead	1000 V CAT II for /MTR1, /MTR2
701902	Safety BNC-BNC Cable	1000 V CAT II, 1 m for /MTR1, /MTR2
701903	Safety BNC-BNC Cable	1000 V CAT II, 2 m for /MTR1, /MTR2
720930	Current Clamp Probe	40 Hz to 3.5 kHz, AC50 A
720931	Current Clamp Probe	40 Hz to 3.5 kHz, AC200 A
751542-E4	Rack Mounting Kit	For EIA
751542-J4	Rack Mounting Kit	For JIS
758917	Test Lead Set	A set of 0.75 m long, red and black test leads
758922	 Small Alligator-clip	Rated at 300 V CAT II two in a set
758923	Safety Terminal Adapter	Two adapters to a set (spring-hold type)
758924	Conversion Adapter	BNC-banana-Jack (female) adapter
758929	 Large Alligator-clip	Rated at 1000 V CAT II and used in a pair
758931	Safety Terminal Adapter Set	Two adapters to a set (Screw-fastened type), 1.5 mm hex Wrench is attached.
761941	WTViewerE	Application Software for WT Series
761951	Safety Terminal Adapter Set	Two adapters to a set for 30 A current (6 mm screw-fastened type)
761952	Safety Terminal Conversion Adapter Set	Two adapters to a set for 5 A current (female-female type)
761953	Safety Terminal Adapter Set	Two adapters to a set for 5 A current (screw-fastened type using B9317WD)
761954	Cable for Current Sensor Element (3 m)	Dedicated cable for current sensor element, total length 3 m
761955	Cable for Current Sensor Element (5 m)	Dedicated cable for current sensor element, total length 5 m
761956	Cable for Current Sensor Element (10 m)	Dedicated cable for current sensor element, total length 10 m
751552	Clamp-on probe	30 Hz to 5 kHz, 1400 Apeak (1000 Arms)
CT2000A	AC/DC Current Sensor	DC to 40 kHz, 3000 Apeak (2000 Arms)
CT1000A	AC/DC Current Sensor	DC to 300 kHz, 1500 Apeak (1000 Arms)
CT1000	AC/DC Current Sensor	DC to 300 kHz, 1000 Apeak
CT200	AC/DC Current Sensor	DC to 500 kHz, 200 Apeak
CT60	AC/DC Current Sensor	DC to 800 kHz, 60 Apeak

Parts number	Product	Description	Order Qty
B9284LK	 External Sensor Cable	Current sensor input connector, Length 0.5 m	1
B9317WD	Wrench	For 761953	1

 Due to the nature of this product, it is possible to touch its metal parts. There is a risk of electric shock - use this product with caution.

*1 Use these products with low-voltage circuits (42 V or less).

Additional option license*

Model	Suffix Code	Descriptions
760991	-DS	Data Streaming
	-G7	IEC Harmonic/Flicker Measurement

*Separately sold license product (customer-installable).

The **isoPRO** is registered trademark of Yokogawa Electric Corporation.

YOKOGAWA

YOKOGAWA TEST & MEASUREMENT CORPORATION
 Global Sales Dept. /E-mail: tm@cs.jp.yokogawa.com

YOKOGAWA CORPORATION OF AMERICA
YOKOGAWA EUROPE B.V.
YOKOGAWA TEST & MEASUREMENT (SHANGHAI) CO., LTD.
YOKOGAWA ELECTRIC KOREA CO., LTD.
YOKOGAWA ENGINEERING ASIA PTE. LTD.
YOKOGAWA INDIA LTD.
YOKOGAWA ELECTRIC CIS LTD.
YOKOGAWA AMERICA DO SUL LTDA.
YOKOGAWA MIDDLE EAST & AFRICA B.S.C(c)

<https://tmi.yokogawa.com/us/>
<https://tmi.yokogawa.com/eu/>
<https://tmi.yokogawa.com/cn/>
<https://tmi.yokogawa.com/kr/>
<https://tmi.yokogawa.com/sg/>
<https://tmi.yokogawa.com/in/>
<https://tmi.yokogawa.com/ru/>
<https://tmi.yokogawa.com/br/>
<https://tmi.yokogawa.com/bh/>

<https://tmi.yokogawa.com/>

YMI-N-MI-M-E03

The contents are as of February 2024. Subject to change without notice.
 Copyright © 2018, Yokogawa Test & Measurement Corporation
 [Ed: 04/b] Printed in Japan, 402(KP)